



igeacom Installation Guide

IgeaCare Systems Inc.

9033 Leslie Street, Unit 7
Richmond Hill, Ontario L4B 4K3 CANADA
Telephone: 1-866-361-6225
Facsimile: 905-707-1775
www.igeacare.com

INTRODUCTION

All igeacom unit model are fabricated with a flame retardant Polycarbonate LEXAN®. All igeacom units are UV-light & water resistant withstanding 260 ft-lb/in² of tensile impact strength. Each igeacom unit is equipped with heat curved silicon rubber buttons.

The igeacom unit has seven (7) physical call points that have the ability to activate an emergency call.

- Red Emergency Button
- Code Blue (CODE)
- Staff Assist (STAFF)
- ¼" Jack
- Wireless Pull Station
- Wireless Pendant
- Hard Wired Input

Compatibility:

UNIT	Transceiver Board	Relay Board	PA Panel Board
Igeacom 600	See note 1	Optional. See note 6	N/A
Igeacom 601	See note 2	Optional See note 6	Included. See note 5
Igeacom 700	Included See note 3.	Optional See note 6	N/A
Igeacom 501	Included See note 4.	Optional See note 6	Included See note 5

NOTES:

1. The igeacom 600 can be upgraded using wireless upgrade kits
Kits include Transceiver Board, screws & spacers.
2. The igeacom 601 can be upgraded using the upgrade kits 2010050 or 2010000.
Kits include transceiver boards, screws & spacers. The PA panel board is not
removable. For more information on the igeacom PA panel board see
Installation Note 101b.
3. The igeacom 700 can be down graded to a 600 by removing the transceiver
board. The igeacom 700 cannot be upgraded to a 701.
4. The igeacom 701 can be down graded to a 601 by removing the transceiver
board. The PA panel board is not removable. For more information on the
igeacom PA panel board see Installation Note 101b.
5. The igeacom 601 & 701 panel board is not removable.
6. For more information on the Relay Board see Installation Note 106.

The igeacom 600 and 601 is supplied with 5 available call points:

A single red call button, code blue, staff assist
1 hard wired input
1 ¼" jack

The igeacom 700 and 701 is supplied with 7 available call points:

A single red call button, code blue, staff assist
1 hard wired input
1 ¼" jack
A maximum of 4 wireless pendants
A maximum of 4 wireless pull stations



GETTING STARTED

What equipment do I need to install an igeacom in a health care facility?

- PBX (for a list of compliant PBX please contact IgeaCare)
- Single Analog port on PBX per igeacom unit
- Single or Multiple Answering IP/Digital Telephones located on the PBX

What do I need to install an igeacom in a suite/room?

- Pre-fabricated 3 gang electrical box or 3 gang caddy or surface mount 3 gang plastic/metal box.

IGEACOM SPECIFICATION

Environment:

- **Temperature:** -20°C to 70°C
- **Humidity:** 0-95%

Details:

- **Weight:** 225g
- **Dimensions:** 6.38" x 1.91" x 4.44" (L x W x H)
- **Dimensions in Electrical Box:** 6.38" x 3.11" x 4.44" (L x W x H)
- **Line Power:** 1.5mA on hook / 28mA off hook; 3.6V Ni-Cd battery back-up (note: charger built on board).
- **Stand-by Battery:** 300mAh capacity continuously internally recharged
- **Backup Time:** 500 hrs of stand-by operation when fully charged.
- **Power Consumption:** N/A

Location:

- Encased in a standard electrical aluminum or plastic deep 3 gang box.

Standards:

- CSA 22.2 #205
- UL 1637
- FCC Part #68 / FCC Part #15
- Class "B"
- CS-03

Transceiver Board (optional):

- **Frequency:** 433.92MHz - compliant to the FCC and ETSI license exempt frequency band.
- **Radio Range:** Up to a maximum of 50ft line of sight.
- **Radio Frequency Inputs (optional):** Set for 2 wireless radio frequency inputs.

Relay Board (optional):

- 1 X 22AWG wire for each colour light to dome light
- 1 X 22AWG common wire to dome light
- 2 X 22-18AWG (Power supply specific) wires to power supply
- **Power Requirements:** 24V AC or DC

PA Hookup (from PA/Panel Board, optional):

- 2 X 20AWG wires to amplifier
- Power Requirements: 200mWATT per igeacom station, 24V

CIRCUIT BOARD OVERVIEW

Igeacom 600:

TAV012
TAV011

Igeacom 601:

TAV112
TAV011

Igeacom 700:

TAV012 (*for more information on TAV112 see Installation Note 101b*)
TAV011
TAV014

Igeacom 701:

TAV112 (*for more information on TAV112 see Installation Note 101b*)
TAV011
TAV014

Relay Output Module (Dome Light Module)

TAV013

For more information on this circuit board see Installation Note 106

TAV011 Overview (MAIN BOARD)

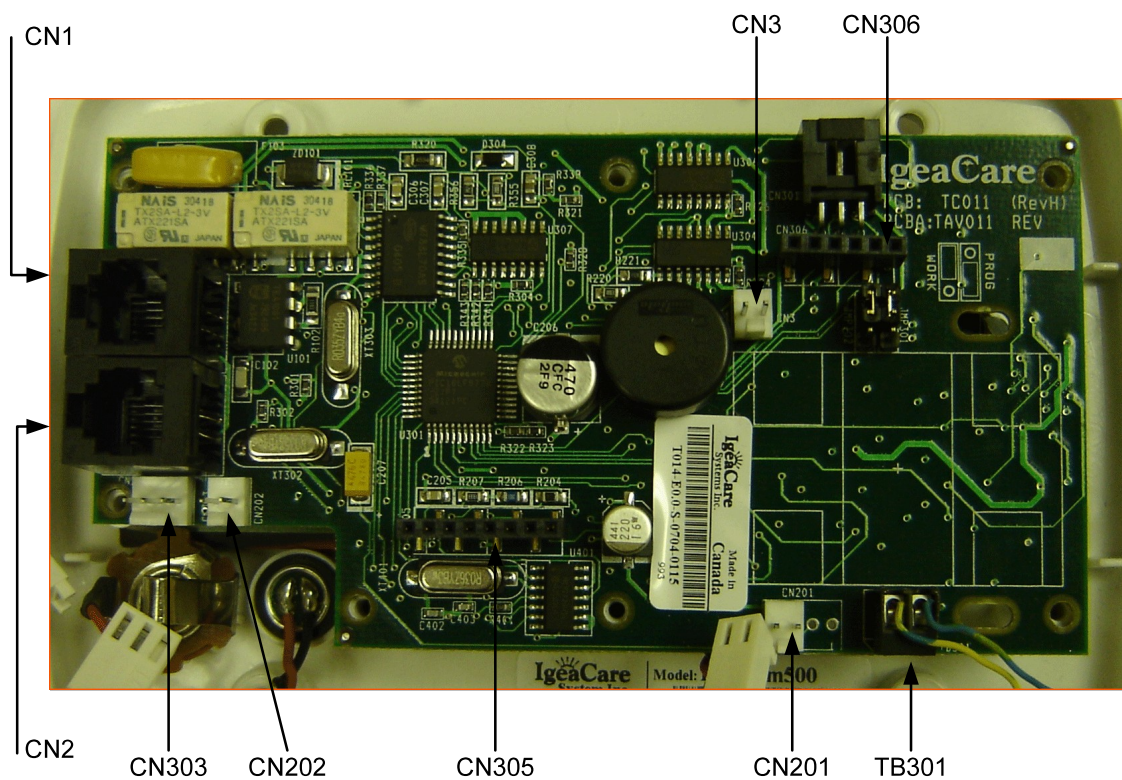

CN1 – Telephone line Input (from PBX)
CN2 – Telephone line Output (to telephone)
CN3 – Two pin header for the connection of the Ni-Cd 3.6V battery pack assembly.
CN306 – Six pin socket for the connection of the Output Relay Module board TAV013
TB301 – Terminal block for normally open momentary short contacts
CN201 – Two pin header is used for the connection of the speaker assembly.
CN305 – Eight pin socket is used for the connection of the Receiver board TAV014
CN202 – Two pin header is used for the connection of the microphone assembly.
CN303 – Three pin header is for the ¼” jack connection, (normally open contact)

Diagram 1.1

PROGRAMMING THE IGEACOM UNIT

Each igeacom is required to be programmed. Please see the Programming Software Guide.

NOTE: The igeacom requires battery power to program. Dial tone is not required for programming.

Quality Care Through Innovative Technology

igeacom Acute Care Software User Guide

V6.08-1.0



IgeaCare Systems Inc.

www.igeacare.com
Toll Free: 1.866.361.6225

Part Number9001002ACS



FIRST EDITION
August 2005

COPYRIGHT

©2005 by IgeaCare Systems Inc. All rights reserved. The content of this document is for information purposes only and is subject to change without notice. IgeaCare Systems Inc. assumes no liability or responsibility for any errors which may appear within this document. The material presented herein should not be construed as a commitment or warranty. No part of this publication may be reproduced, transmitted, transcribed or translated into any language in any form by any means without the express written permission of IgeaCare Systems Inc.

SOFTWARE LICENSE NOTICE

Your license agreement with IgeaCare Systems Inc., which is included with the product, specifies the permitted and prohibited uses of the product. Any unauthorised duplication or use of IgeaCare ACS Version 6.08 in whole or in part, in print, or in any other system is prohibited.

LICENSES AND TRADEMARKS

Macintosh is a trademark of Apple Computer, Inc.

The igeacom logo is a registered trademark of IgeaCare Systems Inc.

QuarkXpress is a registered trademark of Quark, Inc.

Adobe Photoshop is a registered trademark of Adobe Systems Incorporated.

All other brand or product names mentioned in this user's guide are trademarks or registered trademarks of their respective holders.

This document has been produced using QuarkXpress.

All graphics have been taken from the IgeaCare application using Windows Print Screen function and enhanced using Adobe Photoshop.

IgeaCare Systems Inc. wishes to sincerely thank all of the individuals who made this product possible.

IgeaCare Systems Inc.

9033 Leslie Street, Unit #7, Richmond Hill, ON, L4B 4K3, 905.707.1669

Visit our Web site at: www.igeacare.com

Printed In Canada

Section 1 - Software Overview

Getting Started	1-3
Installing the Software	1-4
Accessing the Software	1-5
Initializing the Software	1-6
Software Program	1-8

Section 2 - Programming

Programming Your Units - Green Fields Only	2-3
Phone#	2-4
Delay Minutes	2-4
Redial	2-5
Silent	2-5
Light	2-6
Prio-Priority	2-6
Cancel Button	2-7
Various Delays	2-7
Information Tracking	2-8
Name	2-8
Room #	2-8
Serial #	2-8
Installation Date	2-8

Section 3 - Software Usage

Using The Software	3-3
Store in Palette	3-3
Read from Palette	3-3
Store into Device	3-3
Read from Device	3-4
Verify	3-4
Copy & Paste	3-5
Cancel Yellow Area	3-5
Cancel Green Area	3-6
Exit	3-6
COM Select	3-6
Information Transfers	3-6

1

Software Overview

Getting Started: Installing the Software

Place the CD Software provided to you by IgeaCare Systems Inc., in the cd drive of your computer.

1. Click on **My Computer** to access your cd drive.

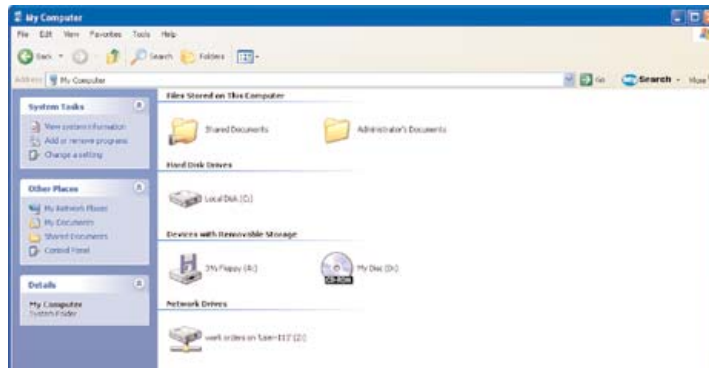

2. Double click on the setup icon to install the software.

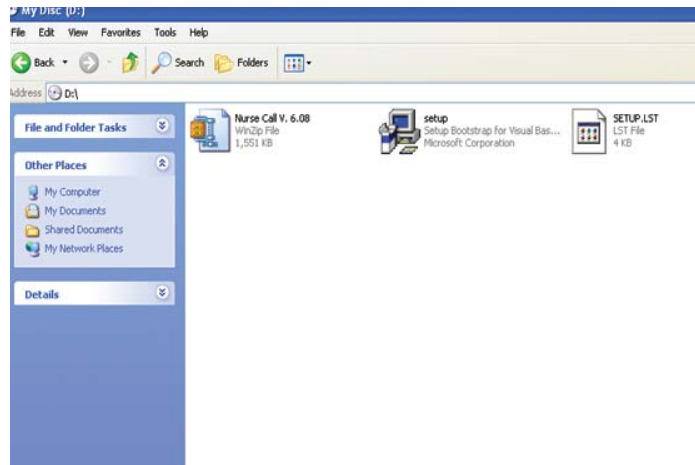

3. After double clicking on the setup file the software will be initialized. When the screen bellow appears, click **OK** if you wish to continue with the software installation process. You may wish to exit the setup process if you are running programs which you do not want to close at this time.

Click **OK** to install the IgeaCare ACS 6.08 software when this screen appears:

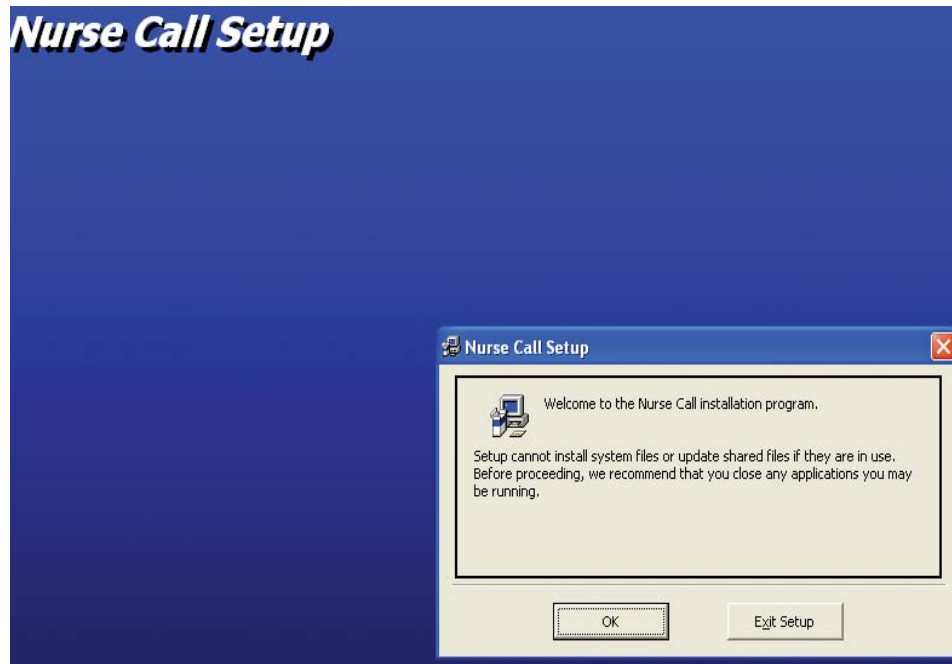

4. Select the directory you would like to install the IgeaCare ACS software. Click the **Install** icon to begin the installation process.

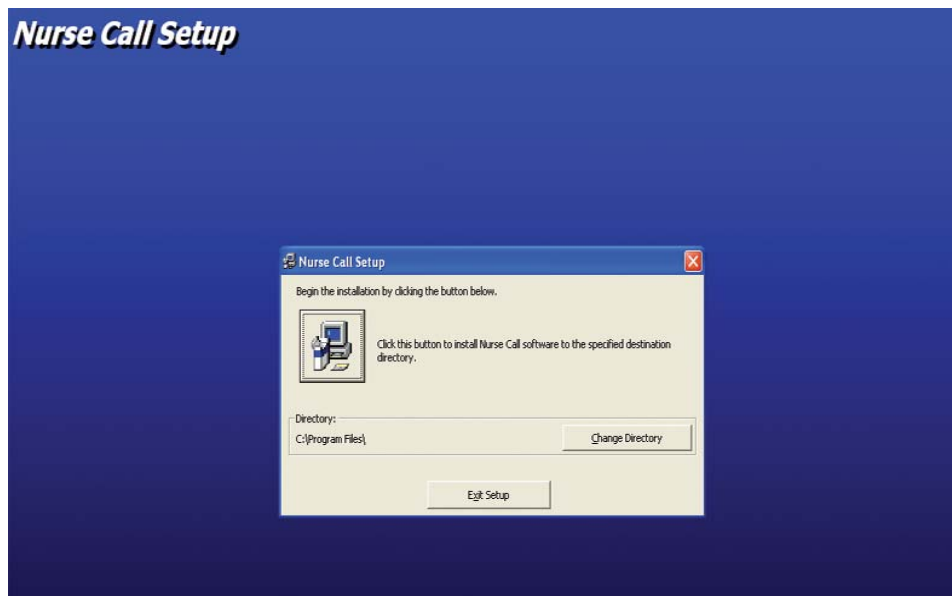

5. Click on **Continue** when this screen appears to continue with the installation process.

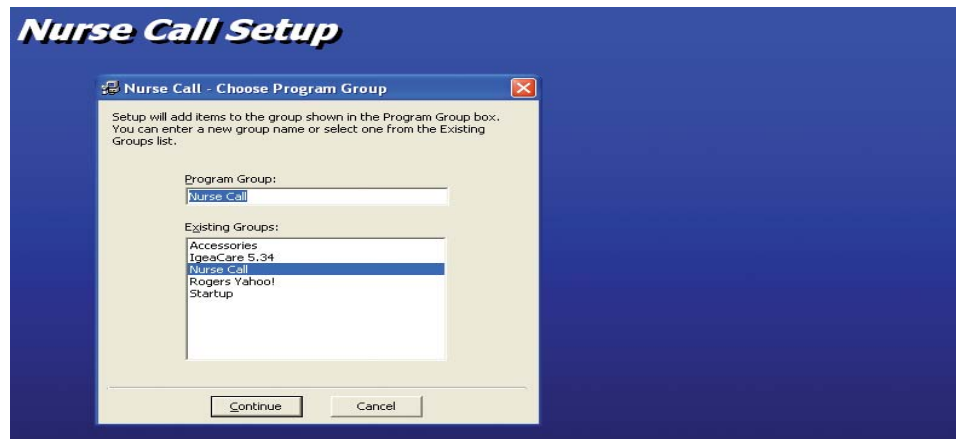

6. Click **OK** when installation states installation successful.



7. Once setup is complete you may access the software by clicking on your **Start** button in the bottom left corner, selecting programs and selecting the IgeaCare Nurse Call 6.08 ACS software.

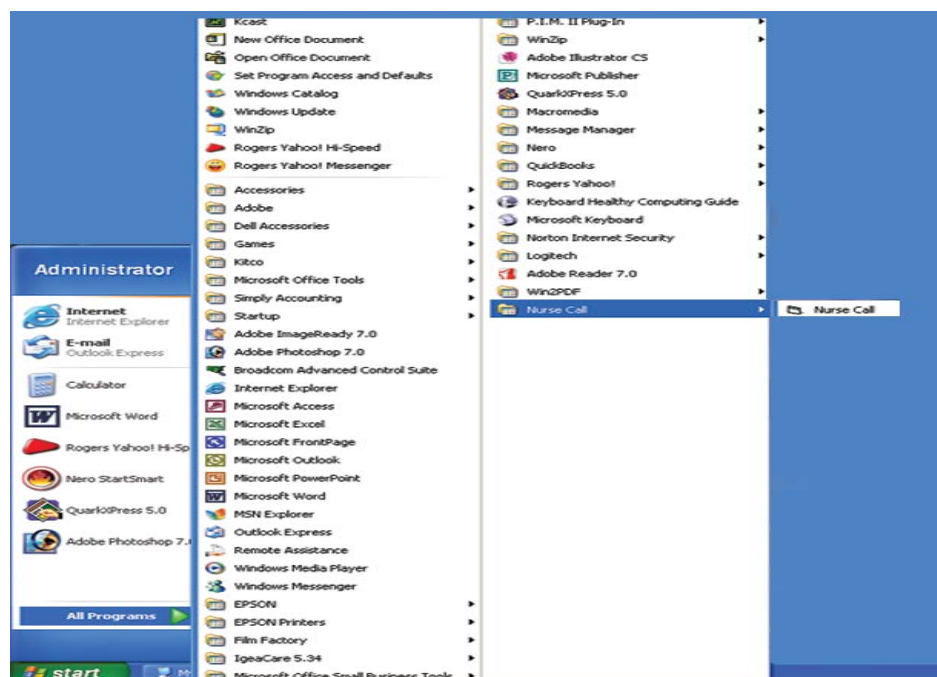

8. Once you have selected to run the IgeaCare 6.08 ACS software, the software will prompt you to follow a few steps to initialize the software. These steps, once completed, will not be required to be repeated again.
9. The first time that the software is accessed, the program will ask you for a user ID code as displayed in the screen below.

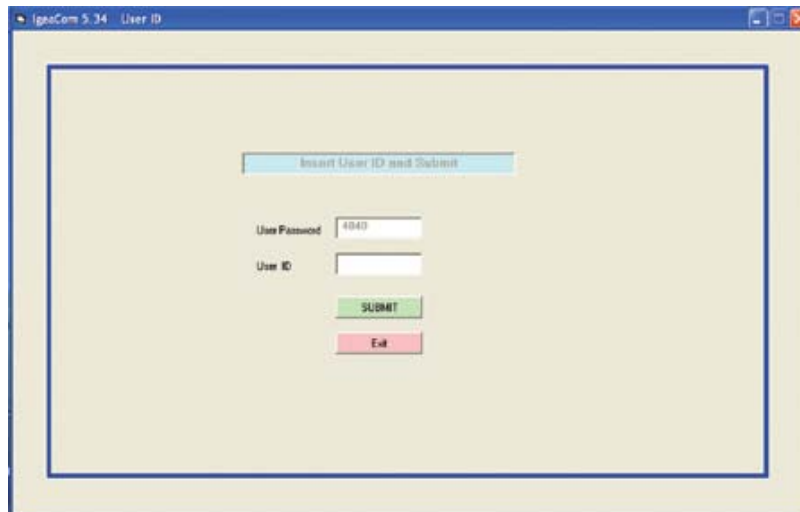

10. A user ID will be provided to you by contacting IgeaCare Systems Inc., at 1 866 361 6225 and disclosing your company related information, your software access key and your current user password to obtain a user ID.

Enter this code, with caution, in the user ID field and press **Submit**.

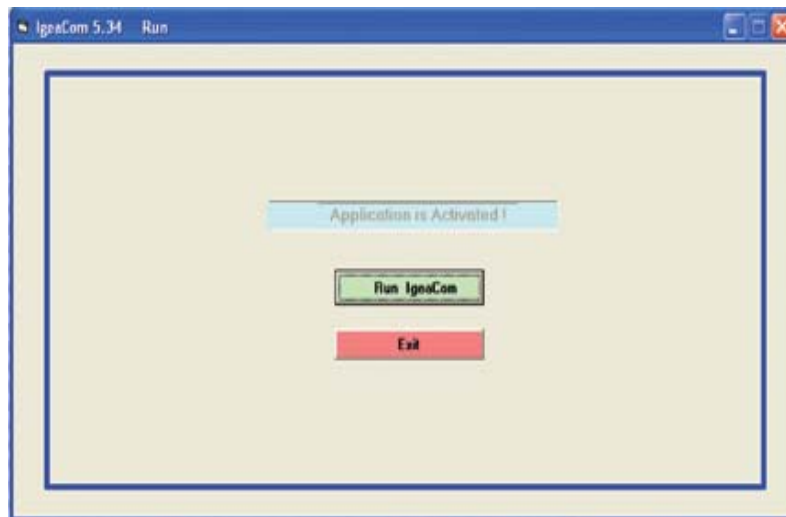

11. The installation of the software is limited and can only be installed on one computer. To obtain additional software access codes you should contact your distributor, sales agent or IgeaCare Systems Inc. If you enter the incorrect ID the following screen will appear. You will be required to contact IgeaCare Systems Inc. to obtain a new user ID login. All logins are kept in our database and are tracked.

Note: The purchase of the software is for one licence use. Additional licences can be purchased to install the software on additional computers.

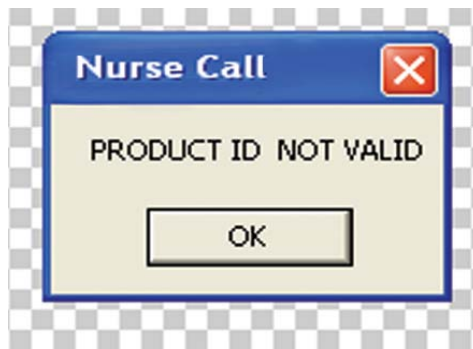

12. If you successfully entered your user ID, the program will then prompt you to run the software. Click on **Run IgeaCare 6.08 ACS**.

If your user ID is not valid then you have inserted an incorrect user ID and will not be prompted to run the software.

If this problem occurs you will be required to contact your distributor, sales agent or IgeaCare Systems Inc.

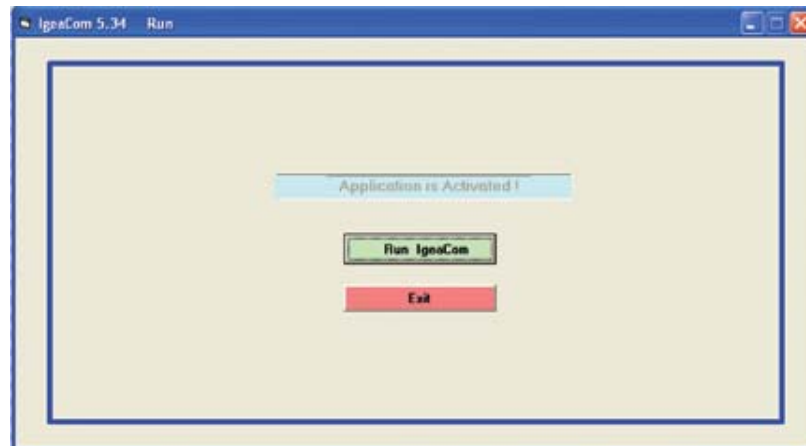

13. If you have successfully installed the software the igeacom software will then load up and appear as follows:

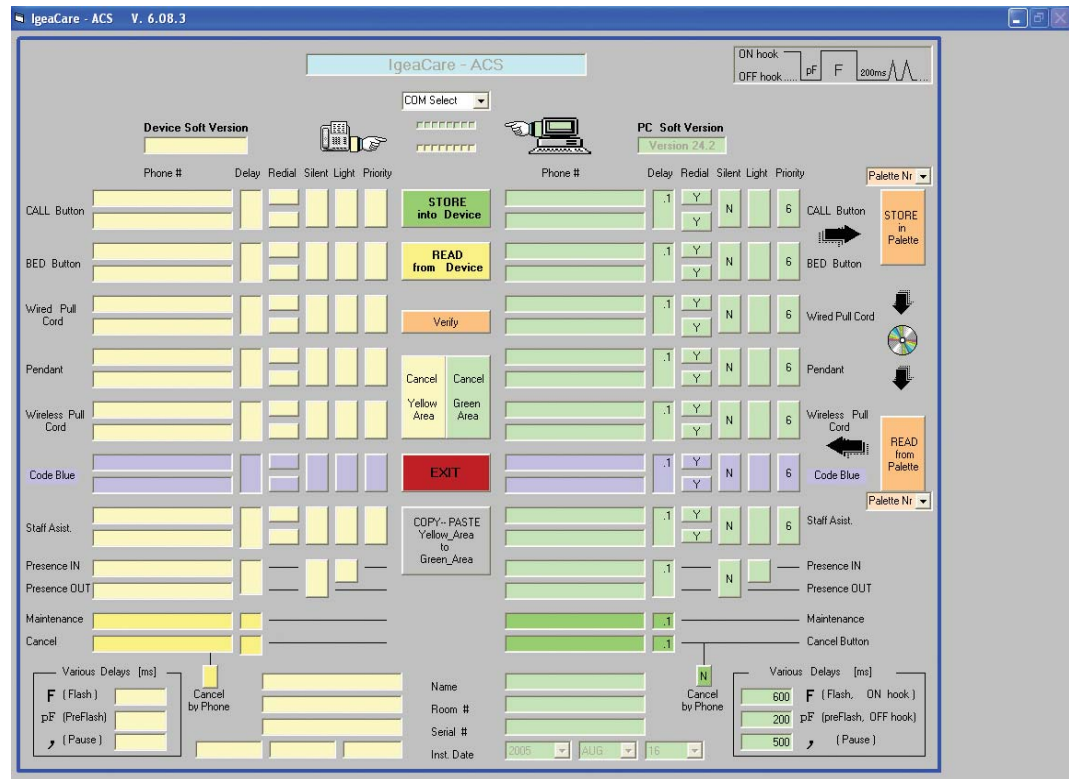

14. At this point you have successfully loaded the IgeaCare software and can begin programming your igeacom devices.

2

Programming

Programming Your Units - Green Fields Only:

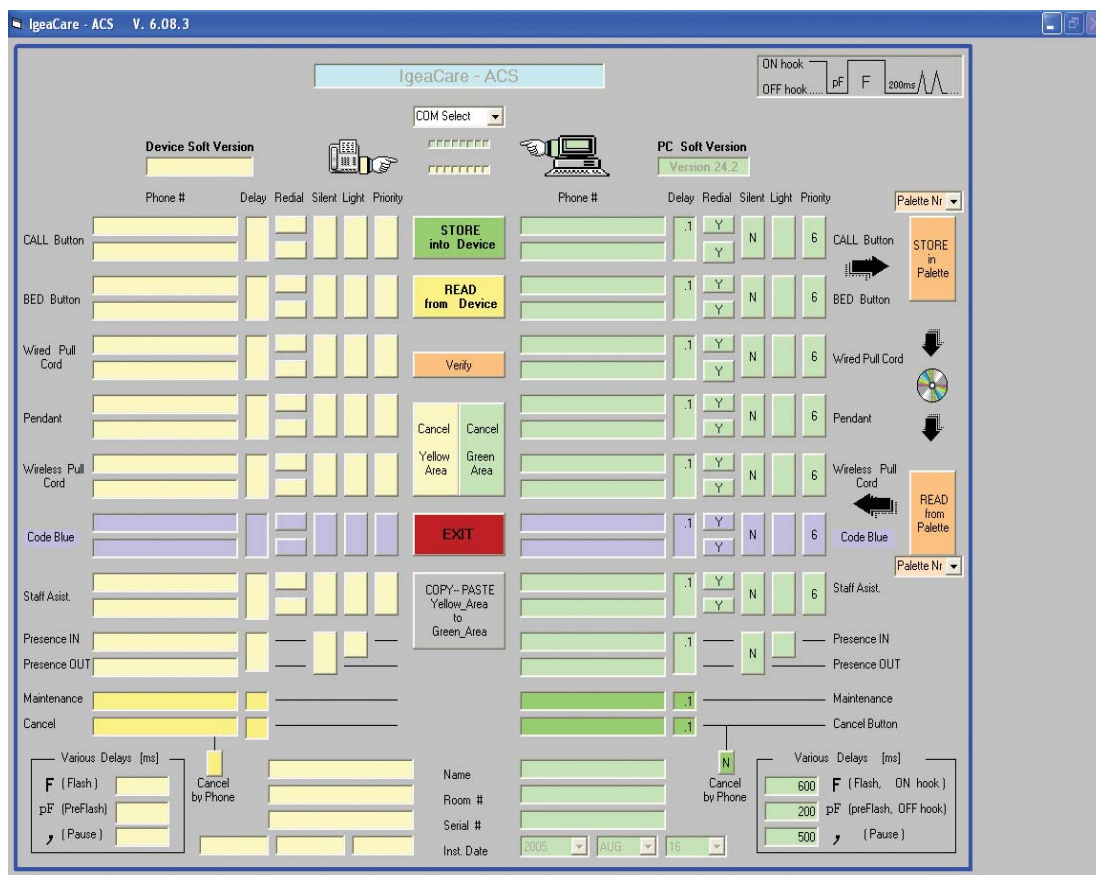

There are five peripheral devices that can be programmed using this software, one device specific button and three activity buttons. They are as follows:

- Row 1: igeacom red emergency call button
- Row 2: Traditional hard-wired push button call cord
- Row 3: Traditional wired pull cord
- Row 4: Wireless pendant
- Row 5: Wireless pull cord
- Row 6: Code Blue
- Row 7: Staff Assistance
- Row 8: Nurse in/out
- Row 9: Maintenance
- Row 10: Cancel Button

For each peripheral device you can set the phone number that will be contacted if the item is triggered. There are six settings and each one will now be discussed in more detail:

Phone #:

Here, you will enter the phone number that the device should dial if the device is triggered. You can enter up to two phone numbers for each device. The first phone number should be your primary contact and the second be the rollover phone number. You can program up to 24 characters.

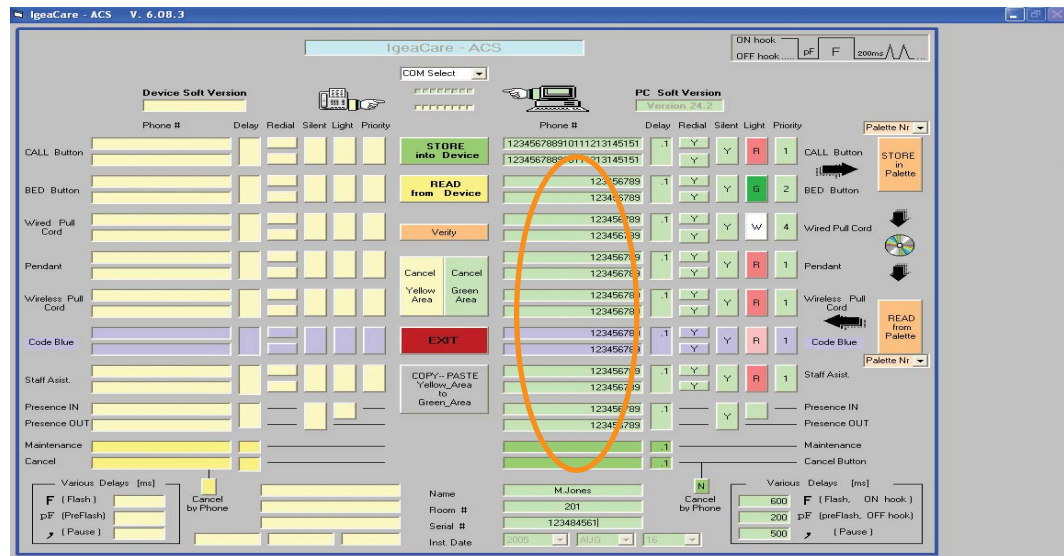

Delay Minutes:

This column represents the amount of time in minutes that the igecom device should wait before dialing the rollover phone number. The standard delay time is two minutes.

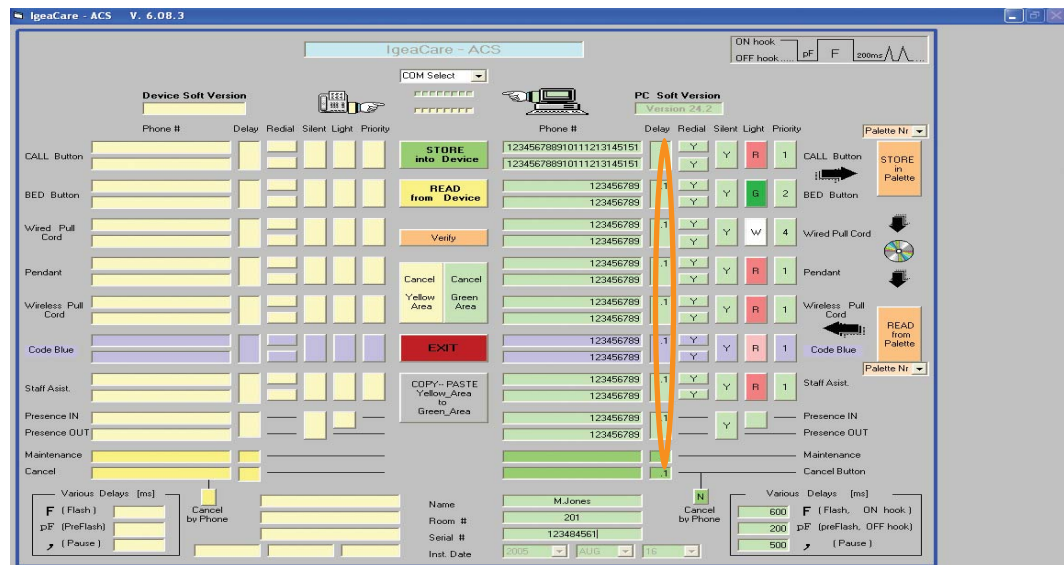

Redial:

If you would like the igeacom device to redial the primary and rollover phone number should no one answer the call, then you should type **Y** for **yes** in this field or **N** for **no** in this field.

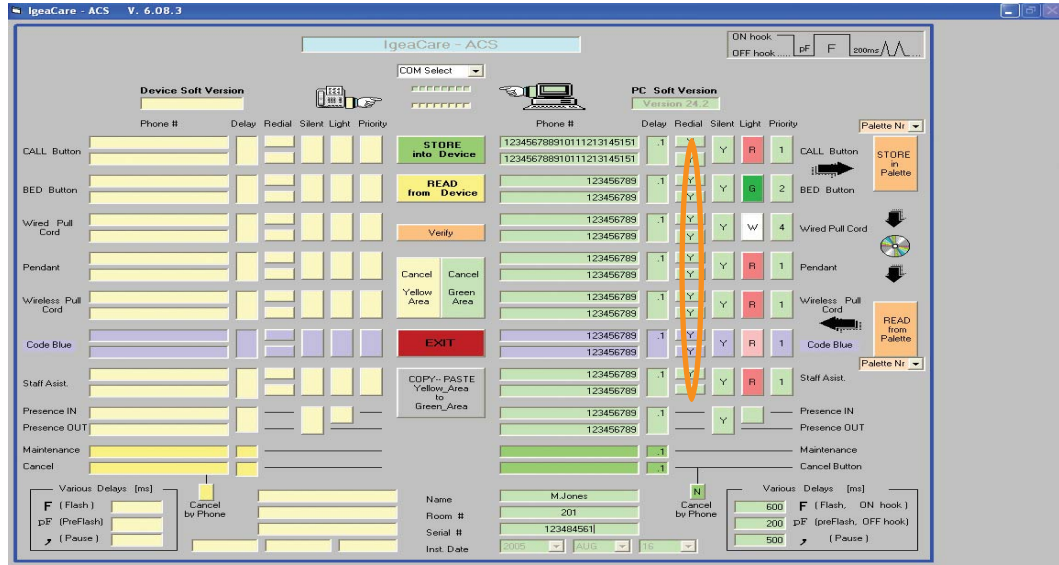

Silent:

Click **Y** for **yes** or **N** for **no** if you do/don't want to hear the igeacom device dial the primary or secondary phone number.

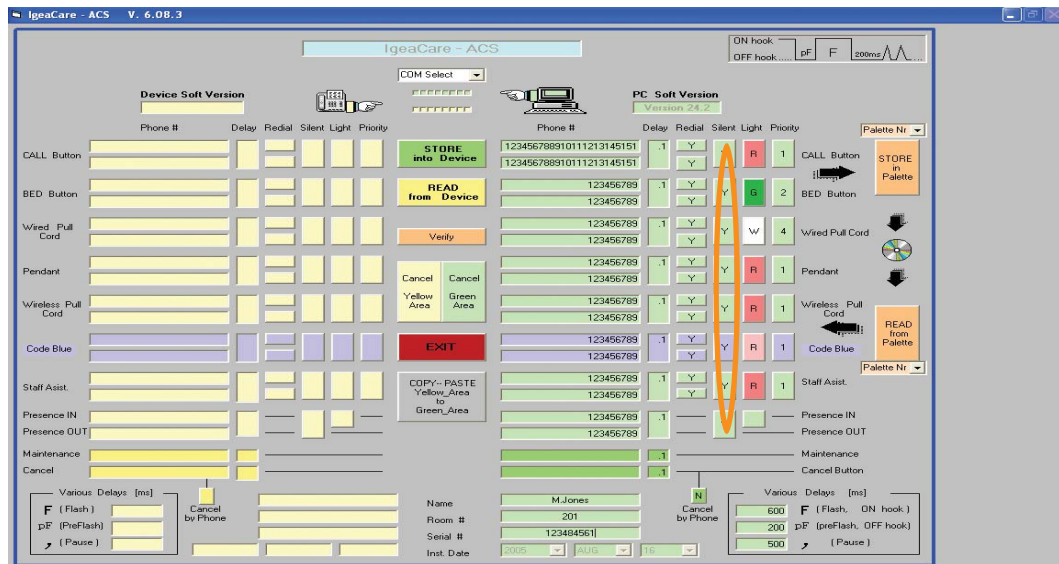

Light:

Click on this field to determine which color in the dome light: red, white, or blue will be lit when a call is made by a specific igeacom peripheral device.

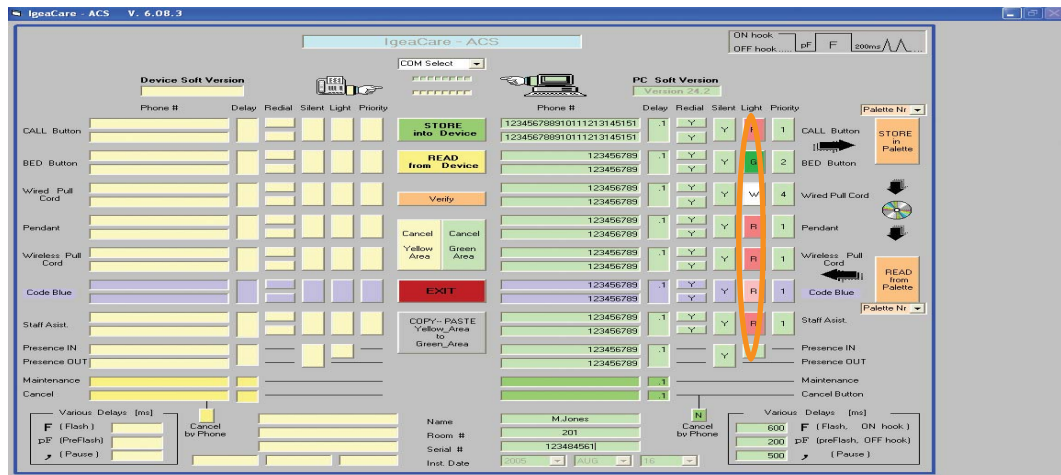

Prio (priority):

In this field each igeacom device can be programmed according to the priority on a scale of 1 to 6. The number 1 signifies the highest priority and the number 6 signifies the lowest priority.

How does the priority function work?

If you are programming 5 igeacom devices you can rank/rate the priority of each device. For example: Row 1: igeacom emergency red call button - 4; Row 2: Traditional hard-wired push button call cord - 4; Row 3: Traditional wired pull cord - 6; Row 4: Wireless pendant - 1; Row 5: Wireless pull cord - 1 and Row 6: Code Blue - 1. These priority levels are shown in the screenshot bellow. If a patient triggers the traditional hard-wired push button call cord the igeacom device will immediately begin dialing the phone number programmed. Should the patient then trigger the pendant, the igeacom device will hang up the previous call made by the traditional hard-wired push button call cord and dial the phone number associated with this device, given the pendant device has been given a higher priority level.

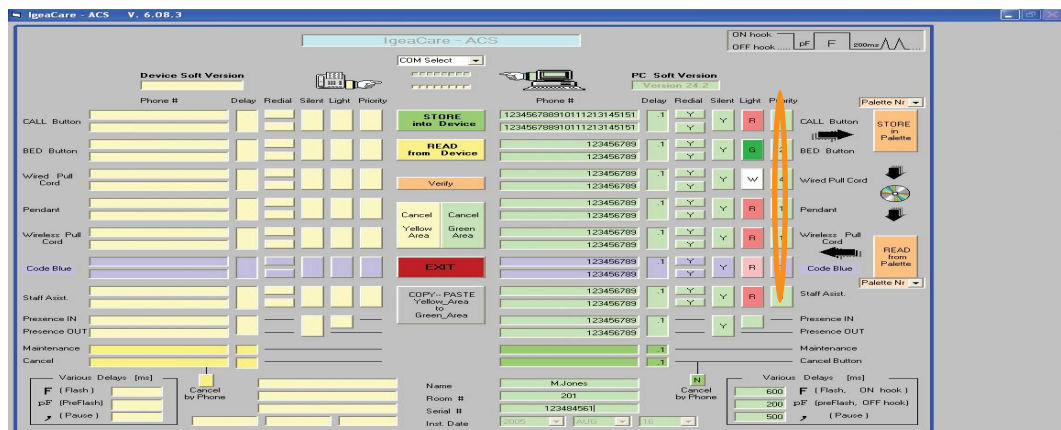

Cancel:

Click on this field to determine if a call should be cancelled at the Igeacom unit or by the staff telephone. Simply click Y for Yes - to be able to cancel a emergency call by the staff telephone or N for No - not to be able to cancel the emergency call from the staff telephone.

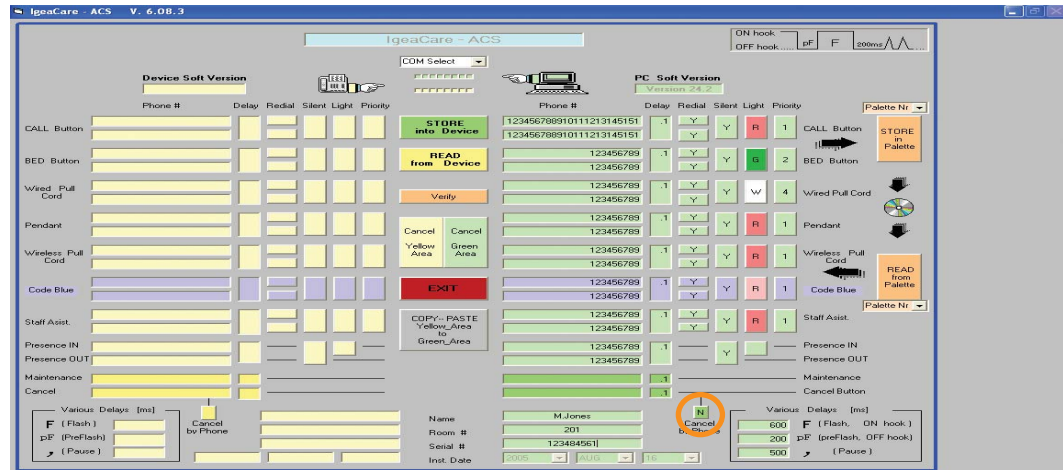

Various Delays:

This option is PBX specific and has been provided in the software for the integration of specific PBX switches. This option is not to be used unless specified by your rep. For additional information relating to the programming of these items please contact your rep or IgeaCare Systems Inc. directly.

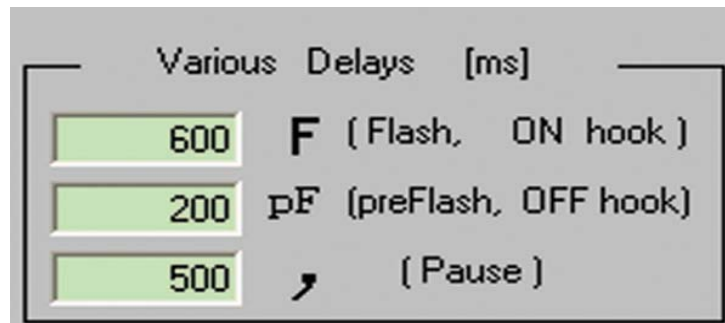

Information Tracking:

The software also enables you to set up the date the igeacom was programmed which can be helpful for future readings of the igeacom. There are four screen fields which can be filled out to help track these changes, they are as follows:

Name:

Type the Name of your organization/hospital or yourself in the green field to the right of this field.

Name	IgeaCare Lodge
Room #	
Serial #	
Inst. Date	Year <input type="text"/> Month <input type="text"/> Date <input type="text"/>

Room #:

Type the Room number in which the unit will be installed in the green field to the right of this field.

Name	IgeaCare Lodge
Room #	702
Serial #	
Inst. Date	Year <input type="text"/> Month <input type="text"/> Date <input type="text"/>

Serial #:

Type the Serial number of the unit in the green field to the right of this field.

Name	IgeaCare Lodge
Room #	702
Serial #	123456789
Inst. Date	Year <input type="text"/> Month <input type="text"/> Date <input type="text"/>

Inst. (Installation) Date:

Select the installation date or programmed date of the igeacom device in the green field to the right of this field.

Name	IgeaCare Lodge
Room #	702
Serial #	123456789
Inst. Date	2004 <input type="text"/> MAR <input type="text"/> 10 <input type="text"/>

3

Software Usage

Using IgeaCare Systems Inc. Software:

Using your infrared programming tool, align the infrared to the unit to detect current parameters and to upload or download new parameters.

Store in Palette Icon: “Write”

The **Store in Palette** icon is used to store the last parameters installed on the igeacom device. You can store up to 12 palettes.



Read from Palette

The **Read from Palette** icon recalls the last parameters installed on the igeacom device. You can read from up to 12 palettes.



Store into Device:

Once you have determined all the parameters to be installed in the igeacom device you should click on the **Store in Palette** icon to store the new parameters and then click on the **Store into Device** button to store the new parameters into your igeacom device.



Read from Device:

If you click on **Read from Device** icon, the parameters programmed in your igeacom device will appear in the yellow area to the left. If you wish to compare these parameters to your new parameters set, simply click **Verify**, and any discrepancies will immediately be identified.

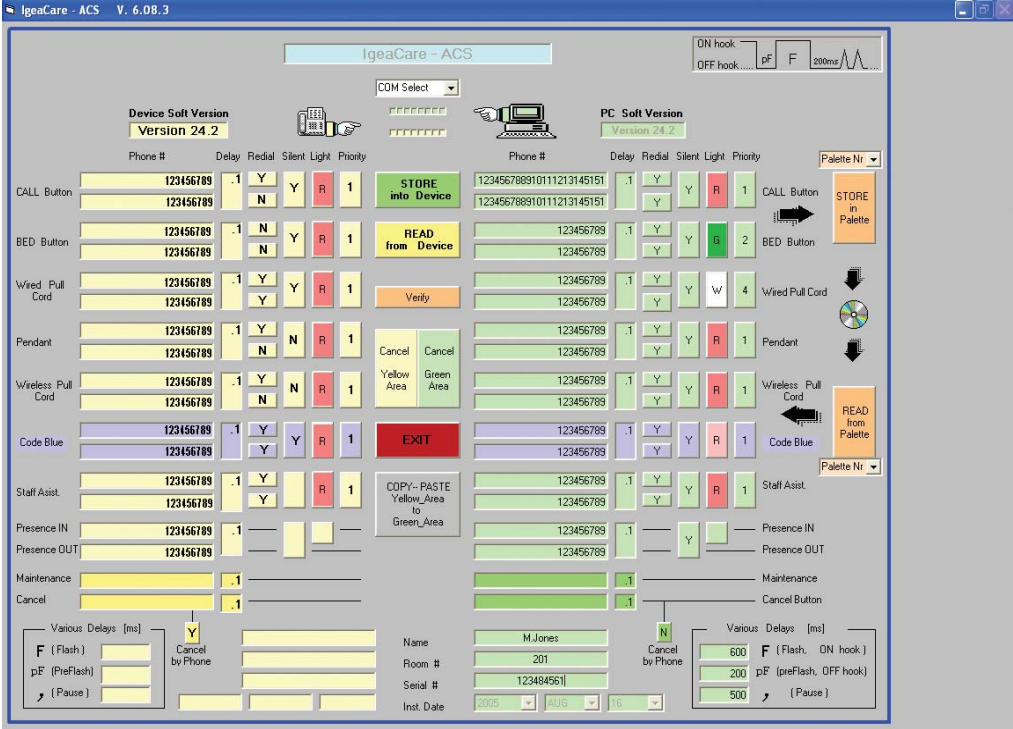

Verify:

The **Verify** icon, once clicked will analyze the difference between the parameters installed in your igeacom device in the yellow area and the parameters stored in your palette in the green area.



Once you have stored the new parameters you may want to check these parameters by clicking **Read from Device**. This option will allow you to read the

parameters installed in the igeacom device. Once the device parameters appear on the left you should then click **Verify**. The verify option will examine if there are any variations between your stored parameters on the right and those read from the device on the left. If there are any discrepancies, they will be immediately identified.

Copy & Paste:

The Copy & Paste Yellow area to Green area icon, once clicked will allow you to copy all the items from the yellow area and paste them in the green area.



Cancel Yellow Area:

If you click on the **Cancel Yellow Area** icon, this will delete all the parameters entered in the yellow fields.

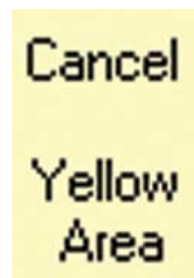

Cancel Green Area:

If you click on the **Cancel Green Area** icon, this will delete all the parameters entered in the green fields.



Exit:

Click on the **Exit** icon if you wish to exit the program.



COM Select:

Click on the **Com Select** icon to connect/program the igeacom unit via infra-red communication. You can select from a list of com ports 1-24

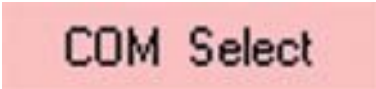

Information Transfers:

Information can be sent in two ways. From the computer to the unit or from the unit to the computer.



UNIT STARTUP

The igeacom unit requires 1.5mAMP on hook look current to ensure the battery holds a charge. It is required that dial tone be present when installing the igeacom units.

1. Booting up the igeacom unit.

NOTE: The battery is shipped fully charged and assembled on the unit. If the battery requires additional charging when install use the IgeaCare Gang Charger. For more information on the Gang Charger see Installation Note 107.

Plug the attached battery into CN3 two pin header on main board TAV011. (figure 1.2)

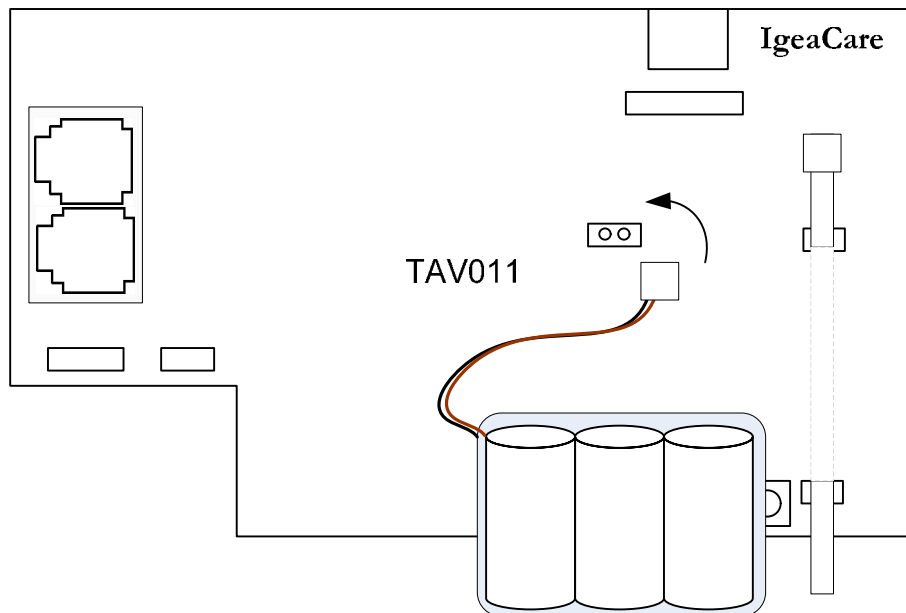

figure 1.2

Every time the battery is plugged into the unit the igeacom will perform a unit diagnostic. During this procedure the unit will:

- a) Check for the line;

- b) Check for a battery warning;
- c) Check to see if the battery voltage is low;
- d) Check to see if the keypad has a seized button.

During the unit diagnostics you will hear the following audible tones:

- a) A single audio beep and the 4 front LED's flash
- b) Pause
- c) 3 short audio beeps
- d) The unit will check for dial tone, no dial tone has been provided so the installer will hear a short chirp. This is normal.

If the above diagnostics is heard the unit has booted up with no errors and is ready for installation.

If a different string of audible tones is heard use the following table to determine the problem:

Line Indicator Light	Audible Tones	Solution
Fault	single short chirp of 70ms in duration.	Fault in Key pad. Check for stuck button/contacts.
Fault	No audible notification	Replace igeacom.
Line & Fault	Single short chirp of 70ms in duration	No dial tone/current is detected.
Activities & Fault	2 chirps of a duration of 160ms each	Battery threshold warning (20%). Battery requires recharging.
Activities, Line & Fault	A long chirp of 560ms in duration	Battery life is critically low. Replace or recharge battery.

Table 1.1

2. Plugging in the telephone line.

Plug in RJ12 to CN1 on the main board TAV011. See diagram 1.3.

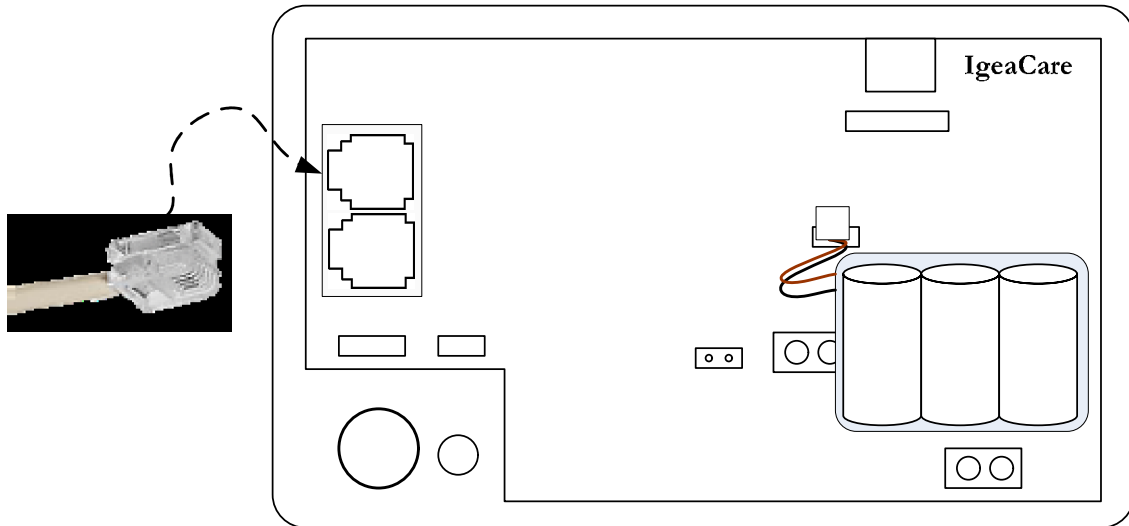

Diagram 1.3



INSTALLING A DEVICE TO TB301

The terminal block (TB301) on TAV011 is a momentary short normally open hard wired input. The device to be installed on this terminal block must have a normally open, momentary short dry contact.

You will require 2 wires from the device to the terminal block TB301. This cable run should be a maximum of 50 feet and must be a home run.

Insert wires from dry contact into TB301 screw terminal. (2 screws)

MOUNTING THE IGEACOM

Slide the igeacom unit in the installed 3 gang electrical box or caddy and mount using 4 screws provided in igeacom packaging box. Secure.

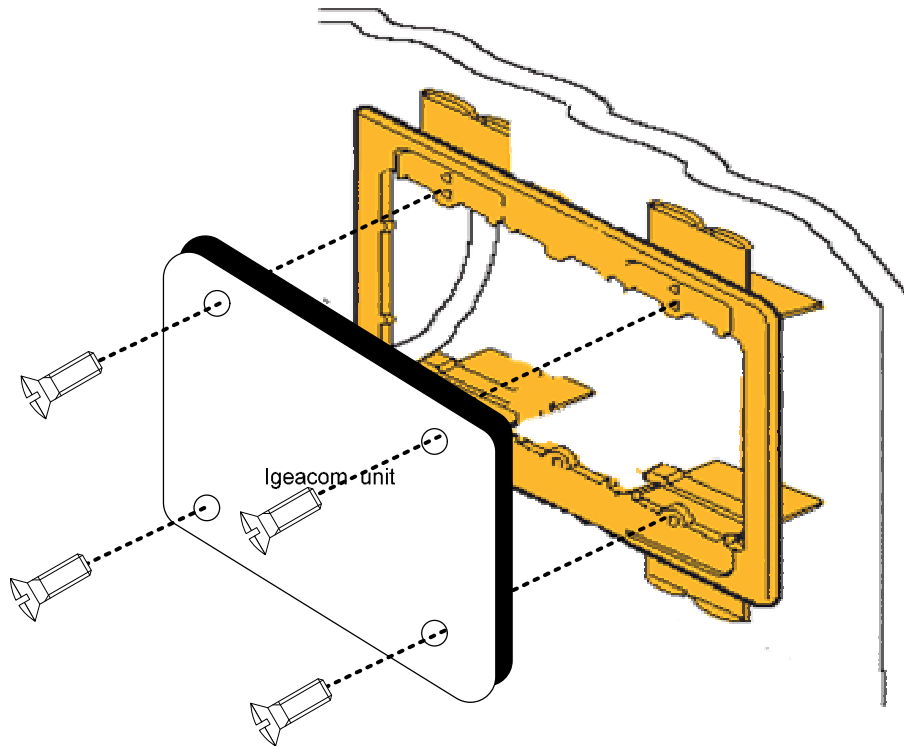

Diagram 1.4

INSTALLING WIRELESS PENDANTS

Programming wireless pendants to an igeacom 500 or 501.

Wireless pendants can be worn by residents/patients as a necklace or bracelet

NOTE: Ensure the igeacom is battery and dial tone is installed on the unit. The igeacom should be mounted to the wall before programming the wireless pendant.

- a. Press and hold the menu & cancel button simultaneously for 5 seconds to put the unit into programming mode. The unit will beep every 10 seconds while in this state.
- b. Press and release the wireless pendant red button. Confirmation tones will be heard on the igeacom and the igeacom will return to a normal state.
- c. Test the pendant by pressing and releasing the red button.

If there is no wireless board installed you will be unable to enter into programming mode. A single igeacom unit with a wireless transceiver board can support a maximum of 4 wireless pendants.

INSTALLING WIRELESS PULL STATIONS

Programming wireless pull stations to an igeacom 500 or 501.

The igeacom wireless pull station is surface mount. It is recommended that it is mounted on a single gang electrical box to ensure it is secure. Residents/users may use this device for support when walking or may pull cord with force therefore a secure mounting is required.

Mount wireless pull station in allocated location using 2 screws provided in packaging (diagram 1.5)

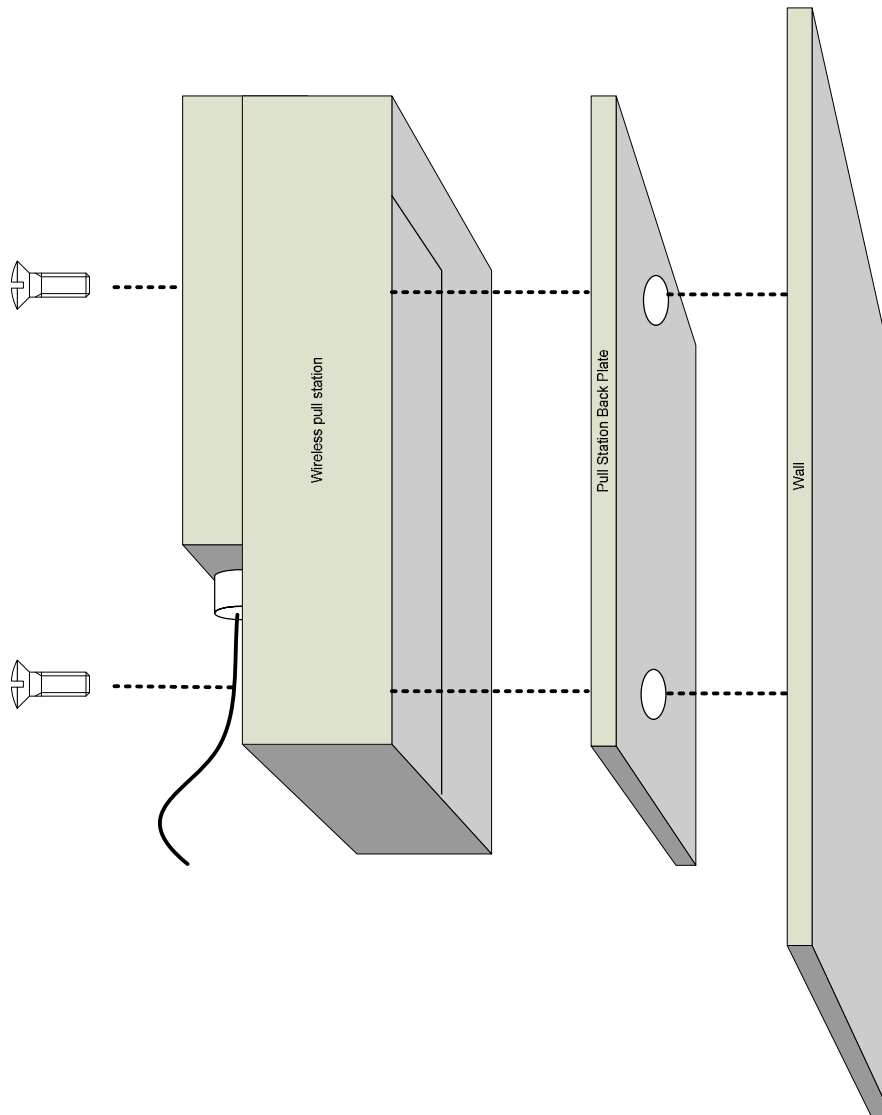

Diagram 1.5

NOTE: Ensure the igeacom is battery and dial tone are installed on the unit. The igeacom should be mounted to the wall before learning the wireless pull station.

- a. Press and hold the menu & cancel button simultaneously for 5 seconds to put the unit into programming mode. The unit will beep every 10 seconds while in this state.
- b. Pull and release the wireless pull station cord or press and release the wireless pull station cancel button. Confirmation tones will be heard on the igeacom and the igeacom will return to a normal state.
- c. Test the pull station by pulling and releasing the cord.

If there is no wireless board installed you will be unable to enter into programming mode. A single igeacom unit with a wireless transceiver board can support a maximum of 4 wireless pull stations.

IN101B – INSTALLING OVERHEAD PAGING

Igeacom 301 & igeacom 501 - PA Panel INSTALLATION NOTE 101b

IgeaCare Systems Inc.

What is in this note?

The note describes the functionality of the PA Panel in both the igeacom 300 & 500 unit. This note provides installation instructions for the igeacom PA system only. For a complete installation training guide for the igeacom unit please contact IgeaCare Systems Inc. at 1-866-361-6225 or visit www.igeacare.com

About the igeacom 301 & 501:

The igeacom301/501 is an igeacom 300/500 with the ability to provide overhead broadcast paging capabilities that can be segregated to specific zones and can even be designed to page specific rooms. The igeacom301/501 can provide both the functions of a nurse call system & the functions of an overhead paging system.

The igeacom 301 & 501 PA panel board is a 1 way overhead paging system. To allow talkback from a resident or emulating an intercom system you must provide the sufficient back end equipment. This equipment is provided by your amplifier supplier and is not an IgeaCare manufactured product. For information on the intercom configuration please see below.

For information on the nurse call features of the 301 & 501 units please see documents relating to the 300 & 500 unit.

Compatibility:

UNIT	Transceiver Board	Relay Board	PA Panel Board
Igeacom 300	See note 1	Optional	N/A
Igeacom 301	See note 2	Optional	Included. See note 5
Igeacom 500	Included See note 3.	Optional	N/A
Igeacom 501	Included See note 4.	Optional	Included See note 5

NOTES:

7. The igeacom 300 can be upgraded using the upgrade kits 2010050 or 2010000. Kits include Transceiver Board, screws & spacers.
8. The igeacom 301 can be upgraded using the upgrade kits 2010050 or 2010000. Kits include transceiver boards, screws & spacers. The PA panel board is not removable
9. The igeacom 500 can be down graded to a 300 by removing the transceiver board. The igeacom 500 cannot be upgraded to a 501.
10. The igeacom 501 can be down graded to a 301 by removing the transceiver board. The PA panel board is not removable.
11. The igeacom 301 & 501 panel board is not removable.

Key Features of the PA Panel:

- Overhead-Broadcast paging.
- Paging can be segregated to zones, multiple zones can be installed(dependant on amplifier)
- Built-in volume control.
- 1 way speaker (for paging function only)
- Paging can be heard in the receiver of the telephone if that telephone is in use and attached to CN2 of the igeacom being paged.

Functionality:

- The PA Panel, when activated will open 1 way communication through the speaker on the igeacom unit. For intercom two-way communication please see Page 6 of this document.
- Dependant on your amplifier you may segregate a group or single room into its own zone.

Important Cable and Connection Information:

- The igeacom 301 and 501 PA Panel's require a dedicated pair of 22AWG wire from each unit to an amplifier. See diagram 1.1.

- Each igeacom 301 or 501 will draw 200mWATT
- The igeacom 301/501 requires a 25V amplifier
- ***If the igeacom units will be used for regular paging within the facility it is recommended that the dedicated pair of wires for the PA Panel board be shielded twisted pair. This will provided minimal cross talk.***
- ***If the igeacom units will be used for emergency paging only (fire, evacuation etc) then the dedicated pair of wires for the PA Panel board may share the same jacket as the telephone line.***

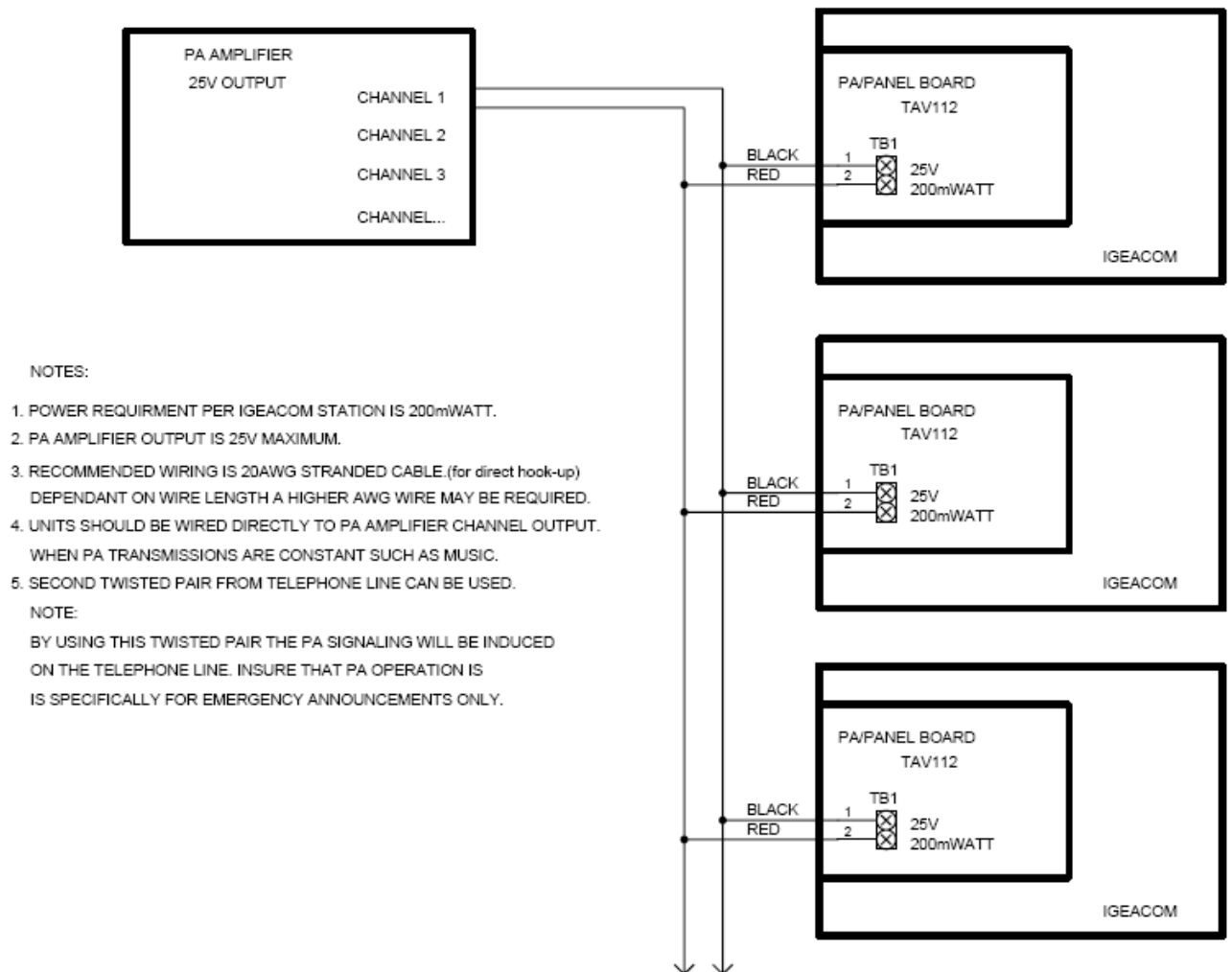

Diagram 1.1

INTERCOM FEATURE

Providing two-way staff initiated paging to a single igeacom unit

Equipment Requirements:

- Multi-zone 25V Amplifier (see above for wattage details).
 - Each zone on the amplifier will be assigned to a single igeacom unit.
- Talk back module
- Igeacom 301 or 501 unit.

NOTE: Please see amplifier manufacturer specifications for a complete list of required equipment.

Functionality:

In order to perform a talk back feature on an igeacom unit you will require each igeacom to be installed on a dedicated zone on the amplifier. The talk back capability resides on the amplifier and not the igeacom. The amplifier will convert the igeacom speaker to a microphone to allow you to have two way hands free voice with the area the igeacom is located in.

NOTE: The igeacom speaker, when used as an intercom, will deactivate automatically if there is no activity for a period of 30 seconds. If the paging party does not speak for 30 seconds the igeacom will deactivate the current connection to avoid staff from intruding on the paged party's privacy.

It is not necessary that the zone number on the amplifier match the room location of the igeacom however for ease of use by the facility it is recommended.

Please contact IgeaCare or your amplifier manufacturer for more information on system paging system design.

IN106 – INSTALLING DOME LIGHTS

Relay Output Module Installation DOME LIGHT MODULE INSTALLTION NOTE 106

IgeaCare Systems Inc.

What is in this note?

The note provides installation notes and requirements for an IgeaCare Relay Output Module for dome light integration. This note describes installation procedures and wiring diagrams of the Relay Output Module, power supply and physical dome light per igeacom unit. For a complete installation training guide for the igeacom unit please contact IgeaCare Systems Inc. at 1-866-361-6225 or visit www.igeacare.com

About the Dome Light:

The dome light will most likely be used in high care facilities such as accute & long term care. The dome light is mounted above or beside the entrance to each room as shown in floor plans provided by the customer. When a call point is triggered a call is placed along with a light is activated on the dome light alerting nurses who may be passing in the hall. When the call is cancelled the light is turned off.

Required Equipment:

- Dome Light (AC or DC – both are supported). Each dome light shall be secured to a two-gang back box. Dome lights include 3 bulbs (RED, WHITE, GREEN)
- Relay Output Module (DOME LIGHT MODULE) installed on each igeacom that is required to activate a corridor dome light.
- 24V power supply. Power Supply current must be the same as dome light current.
 - Each dome light requires .83AMPS on a 24V power supply or 20VA. To determine how many dome lights are supported on your power supply (P/S) use the following calculation:

P/S WATTAGE divided by P/S VOLTAGE = available AMPAGE

For example: A 24V, 400WATT power supply can support 20 dome lights.

NOTE: dome lights ampage is calculated assuming a 24V power supply will be used. If you choose to install a power supply with a different voltage the ampage requirements of the dome light may differ.

Functionality:

- Multiple igeacom may activate a single dome light.
- The igeacom can only activate a single bulb at one time.
- Dome lights will only power on if the igeacom has dial tone provided from a PBX/External source
- Each igeacom call point can be programmed to turn on a different colour bulb using the programming software

Important Cable and Connection Information:

Cabling requirements:

- Requires 2 X 18AWG wires from the power supply to each Relay Output Module (DOME LIGHT MODULE). NOTE: the AWG of the wire is determined by the power supply installed and the length of the cable. See power supply manufacturer specifications or contact IgeaCare for more information
- Requires a single 20-22AWG wire from each bulb required to turn on in the dome light to the Relay Output Module (DOME LIGHT MODULE). For example, 3 different colour bulbs will require 3 wires.
- Requires a single 20-22AWG common wire (ground) from the dome light to the Relay Output Module (DOME LIGHT MODULE). This wire is the ground for all bulbs.

See wiring diagram 1.1 and diagram 1.2

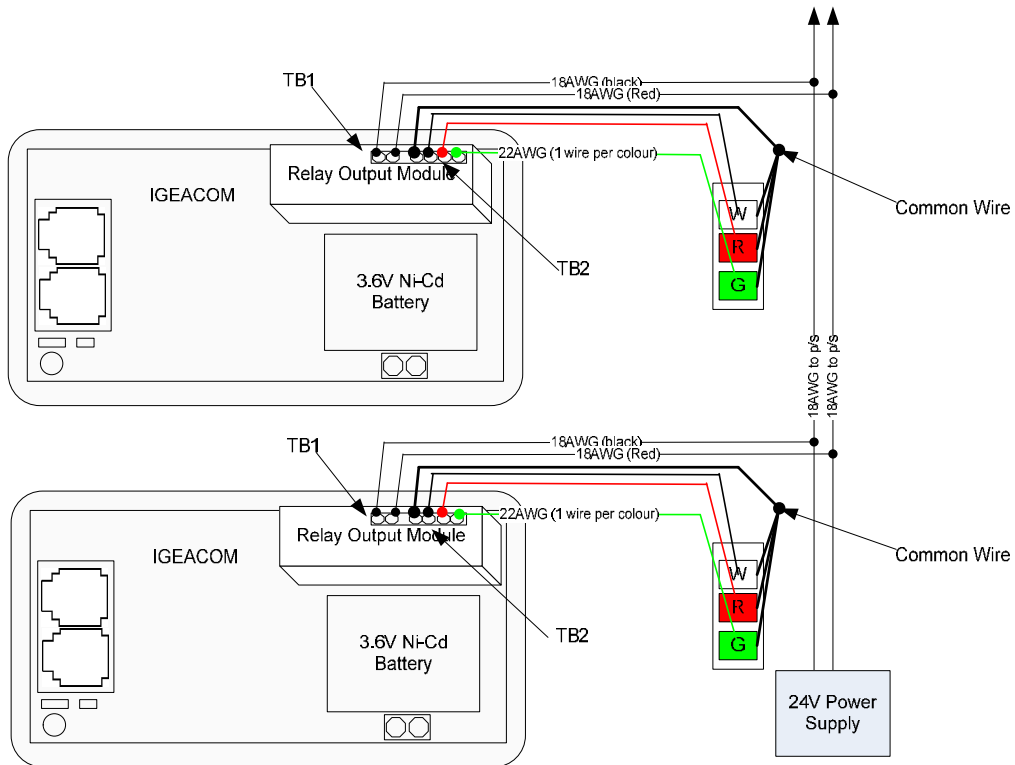

diagram 1.1

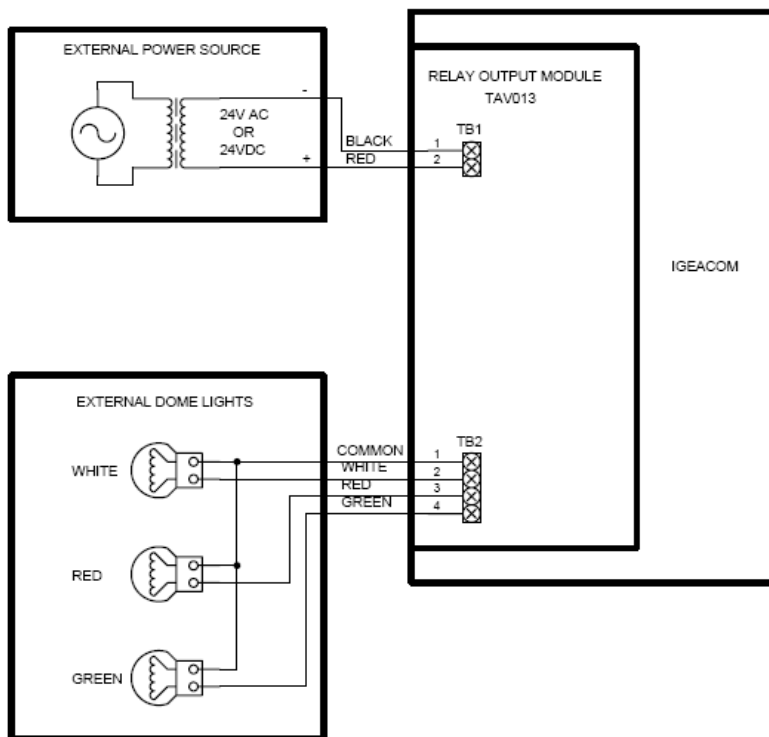

Diagram 1.2

In an actual health care facility the recommended wiring configuration is shown in diagram 1.3

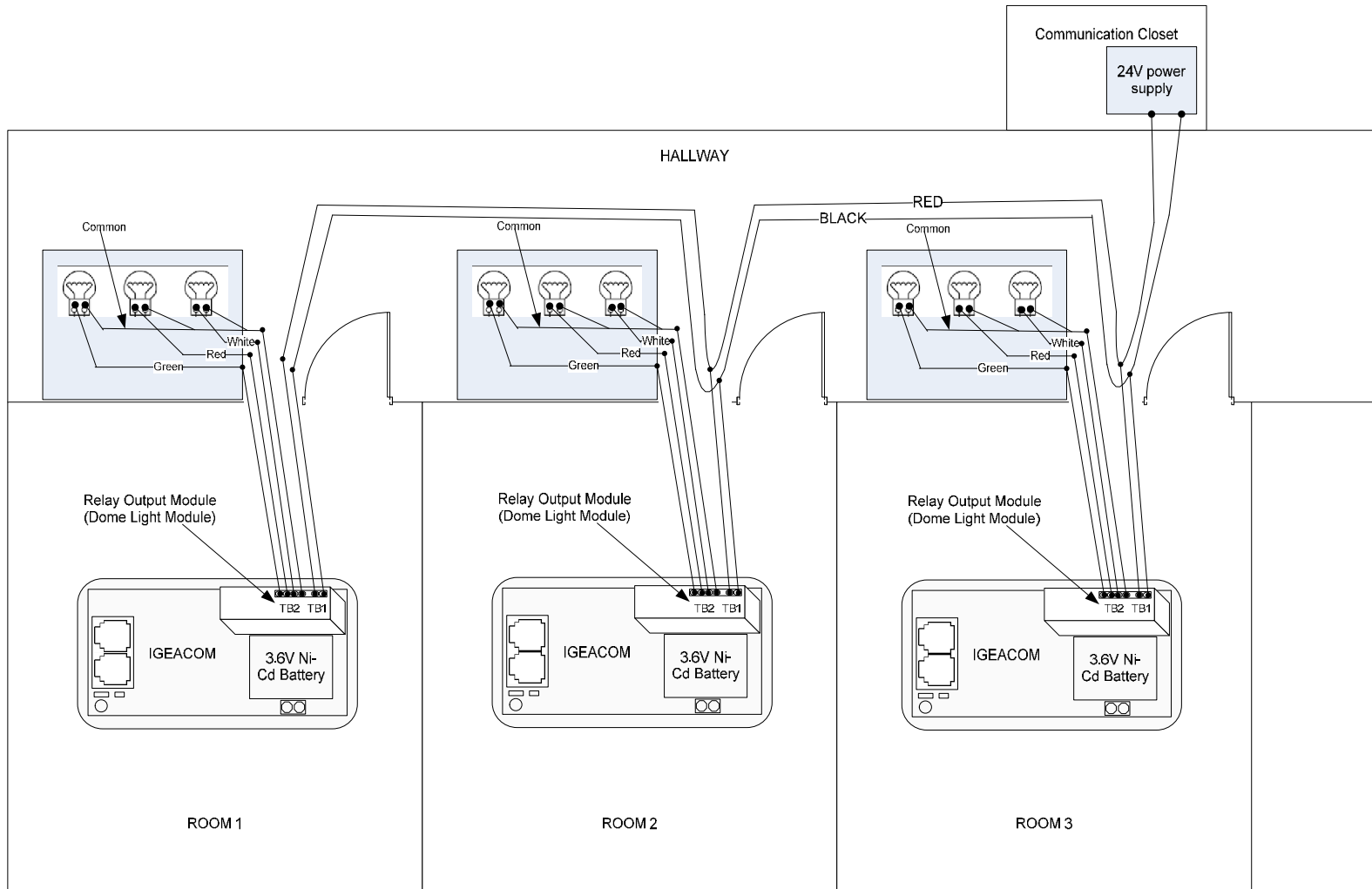

diagram 1.3

Relay Output Module Installation:

- If the relay output module (dome light module) are purchased with an igeacom the unit will come with the module already installed.
- If the relay output module (dome light module) is an upgrade to an existing unit please refer to diagram 1.4 for installation.

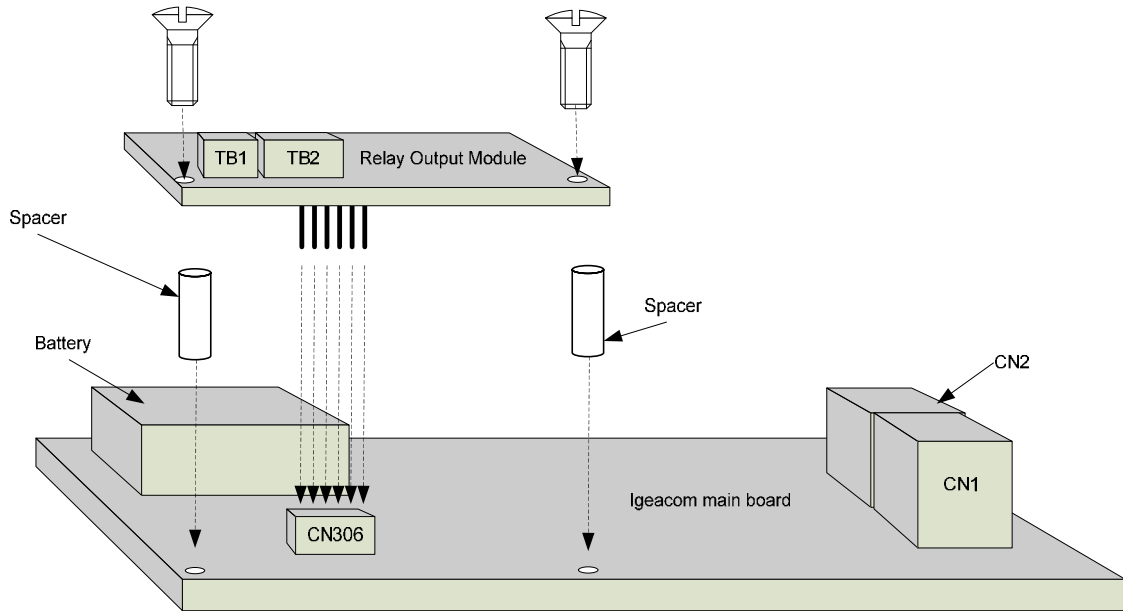

diagram 1.4

IN108 – MP501

igeacom Multi-Pendant 501 INSTALLATION NOTE 108 *IgeaCare Systems Inc.*

What is in this note?

The note describes the functionality of the igeacom MP501. This note provides information on the multi-pendant function only. For a complete installation training guide for the igeacom unit please contact IgeaCare Systems Inc. at 1-866-361-6225 or visit www.igeacare.com

About the igeacom MP501:

The MP501 unit provided includes the same features as the igeacom 501, however, it also includes the ability to activate using an unlimited number of pendants(3001001) & a maximum of 4 wireless pull stations (3001050).

For installation and technical notes on the igeacom 501 please contact an IgeaCare representative or visit www.igeacare.com or refer to technical bulletin 101, PA Paging.

Specifications:

Environment:

- **Temperature:** -20°C to 70°C
- **Humidity:** 0-95%

Details:

- **Weight:** 225g
- **Dimensions:** 6.38" x 1.91" x 4.44" (L x W x H)
- **Dimensions in Electrical Box:** 6.38" x 3.11" x 4.44" (L x W x H)
- **Line Power:** 1.5mA on hook / 28mA off hook; 3.6V Ni-Cd battery back-up (note: charger built on board).
- **Stand –by Battery:** 300mAh capacity continuously internally recharged
- **Backup Time:** 500 hrs of stand-by operation when fully charged.
- **Power Consumption:** N/A

Location:

- Encased in a standard electrical aluminum or plastic deep 3 gang box.

Internal Hardwire Input Connections:

- 1 X Telephone input line cord (40mA-50mA) with standard modular plug.
- 1 X Telephone output line cord (40mA-50mA) with standard modular plug.
- 1 X Rear terminal block hook up for momentary short /normally open contacts.

External Hardwire Input Connections:

- 1/4" Phone plug with Cordette Nurse Call Switch.

Standards:

- CSA 22.2 #205
- UL 1637
- FCC Part #68 / FCC Part #15
- Class "B"
- CS-03

Transceiver Board:

- **Frequency:** 433.92MHz - compliant to the FCC and ETSI license exempt frequency band.
- **Radio Range:** Up to a maximum of 50ft line of sight.
- **Radio Frequency Inputs (optional):** Set for 2 wireless radio frequency inputs.

Relay Board (optional):

- 1 X 22AWG wire for each color light to dome light
- 1 X 22AWG common wire to dome light
- 2 X 22-18AWG (Power supply specific) wires to power supply
- **Power Requirements:** 24VAC

PA Hookup (from PA/Panel Board, TAV112):

- 2 X 20AWG wires to amplifier
- Power Requirements: 200mWATT per igeacom station, 25V

Compatibility:

UNIT	Transceiver Board	Relay Board	PA Panel Board
Igeacom MP501 ¹	Included*	Optional	Included

NOTES:

12. A MP501 unit cannot be downgraded to a 500 unit.
 *The igeacom wireless transceiver board includes the multi-device firmware upgrade. There is no change to firmware on the TAV011 main board.

Key Features of the Multi-Pendant Unit:

- Unlimited pendants can activate this unit
- A maximum of 4 wireless pull stations can activate this unit. Wireless pull stations require a technician to perform the learn procedure to activate.
- Programming individual pendants or wireless pull stations is not required. If an IgeaCare manufactured wireless device is within 50ft of the unit and is pressed it will activate automatically.
- *Can be used as a common area device.
- Supports overhead 1-way paging (equipped with PA Panel board, TAV112)

Functionality:

- The igeacom MP501 provides all the same features as the igeacom 501
- The MP units should not be installed in a residential suite. MP units will not be able to be programmed with individual pendants. All pendant/pull station activations if within receiver range will activate the igeacom MP unit.
- Units should be spaced an average of 100' from each other. A site survey is recommended before installation to ensure the units are placed so that the entire area required is covered.
- ***NOTE: If the units are in close proximity to each other false calls may be placed. Two units sharing the same radius may activate at the same time. Signal may leak not only horizontally but vertically also.***
- ***Units may also send false calls if a pendant is activated and registered to a residential igeacom (500/501) that is in close proximity to an MP unit.***

**coverage area may vary depending on building construction and environmental conditions in which the unit is installed. Site surveys are strongly recommended by IgeaCare.*

IN107 – GANG CHARGER

igeacom Battery Gang Charger INSTALLTION NOTE 107 *IgeaCare Systems Inc.*

What is in this note?

The note provides setup notes for the IgeaCare 25 battery gang charger. This note describes the purpose of the gang charger and each component. For more information about battery care and charger please contact IgeaCare Systems Inc. at 1-866-361-6225 or visit www.igeacare.com

ABOUT THE GANG CHARGER

The gang charger is supplied to installers or dealers for equipment staging purposes. Before units are installed all batteries are to be charged using the gang charger and tested to ensure full capacity is met before installation. The gang charger consists of a power supply with the 25 battery cradle. Please see diagram 1.1 for gang charger part description.

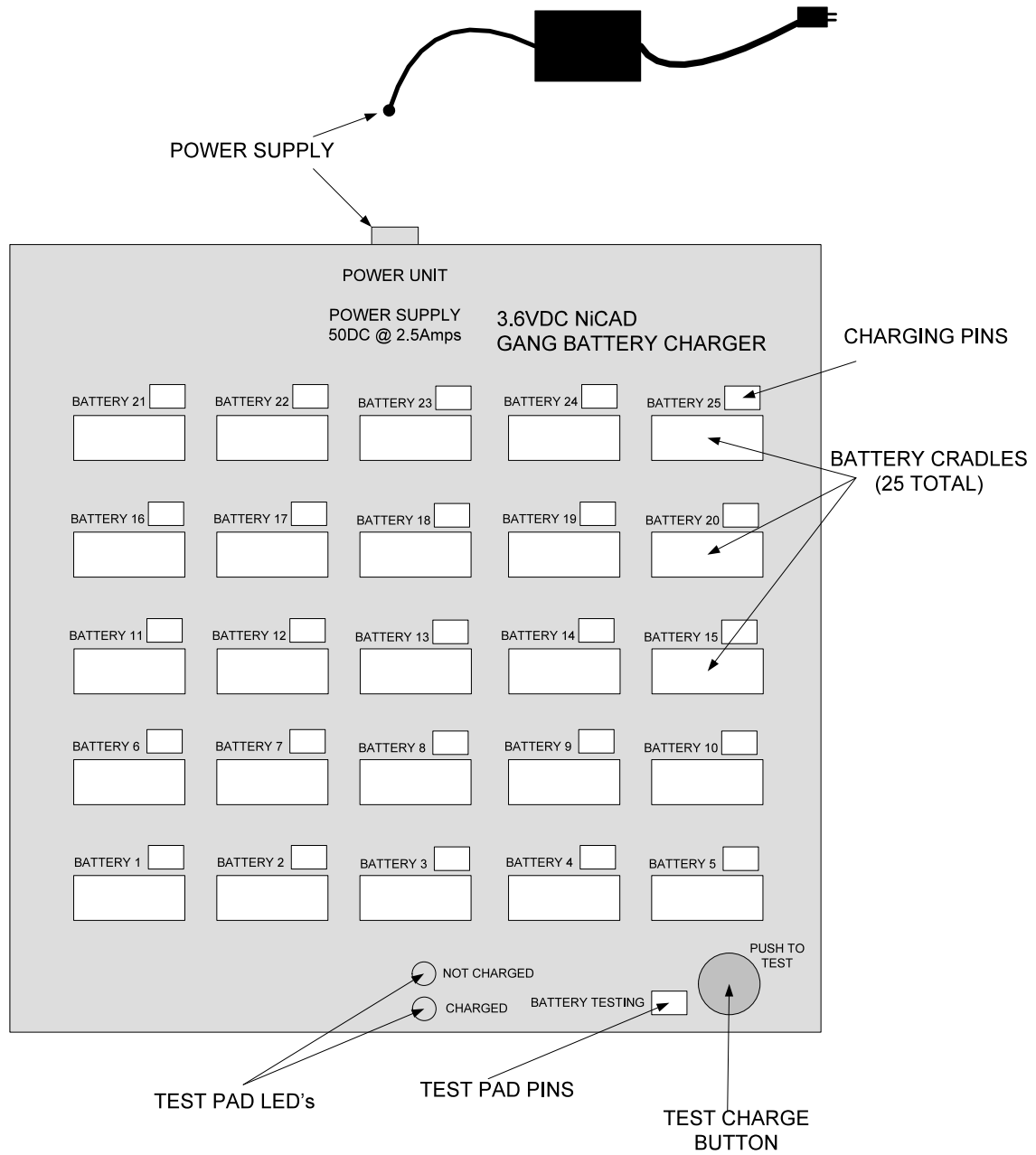
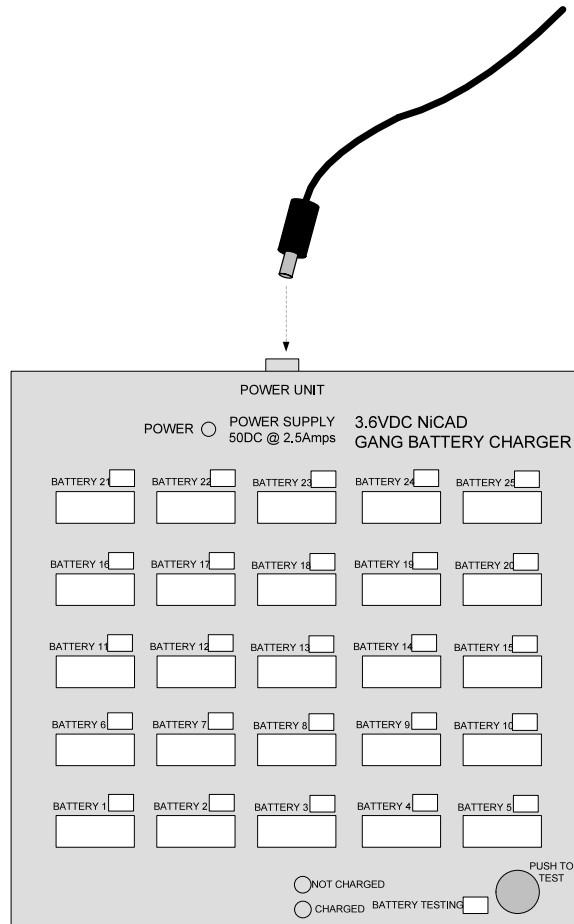

diagram 1.1

INSTALLATION INSTRUCTIONS:

1. Plug in the power supply provided to the power input on the top of the gang charger. Plug the power supply into an external power source. You will know that power is flowing when the red POWER LED is on.



2. Place a battery in one of the available cradles.

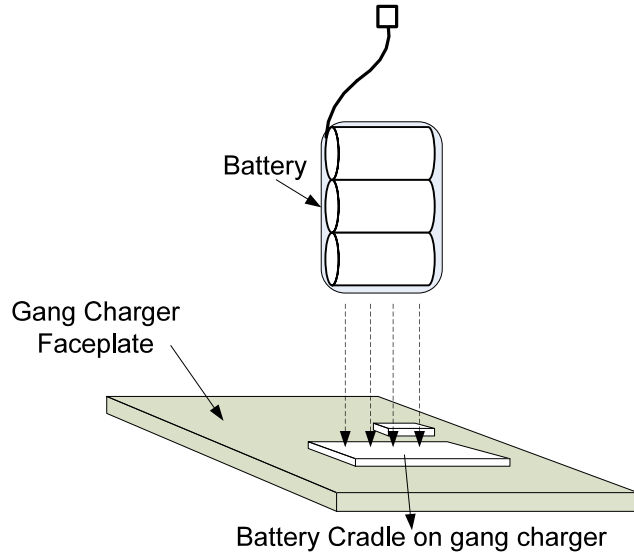

3. Plug the battery connector it in to the corresponding charging pins.
NOTE: DO NOT FORCE

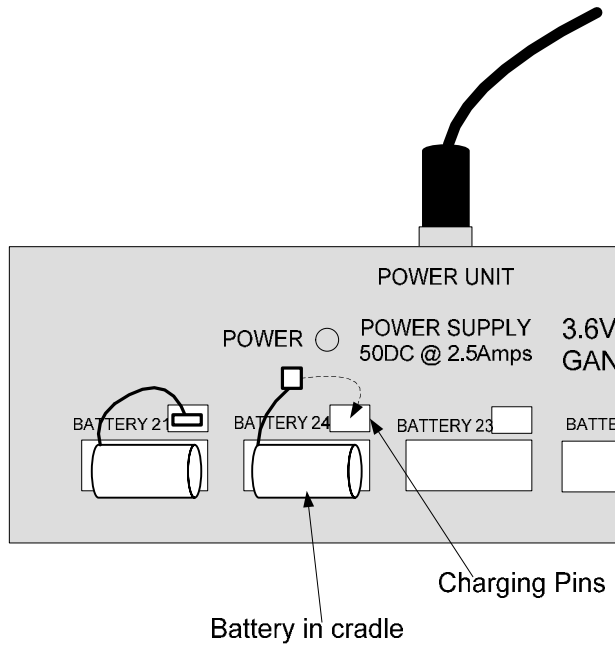

CHARGING INSTRUCTIONS:

- For a fully dead battery leave on charger for a period of 24 hours.
- **DO NOT LEAVE A BATTERY ON THE CHARGER FOR LONGER THAN 24 HOURS.**
- Test all batteries on gang charge test pad after charging is completed.
- Up to 25 batteries can be charged at one time. (a total of 25 is not required)
- Batteries on charger are plug in play.

TESTING A BATTERY:

After a battery has been on the cradle for up to, but no more than, 24 hours, use the test pad for verification that it is fully charged.

1. Plug the battery connector into the Test Pad Pins at the bottom of Gang Charger.

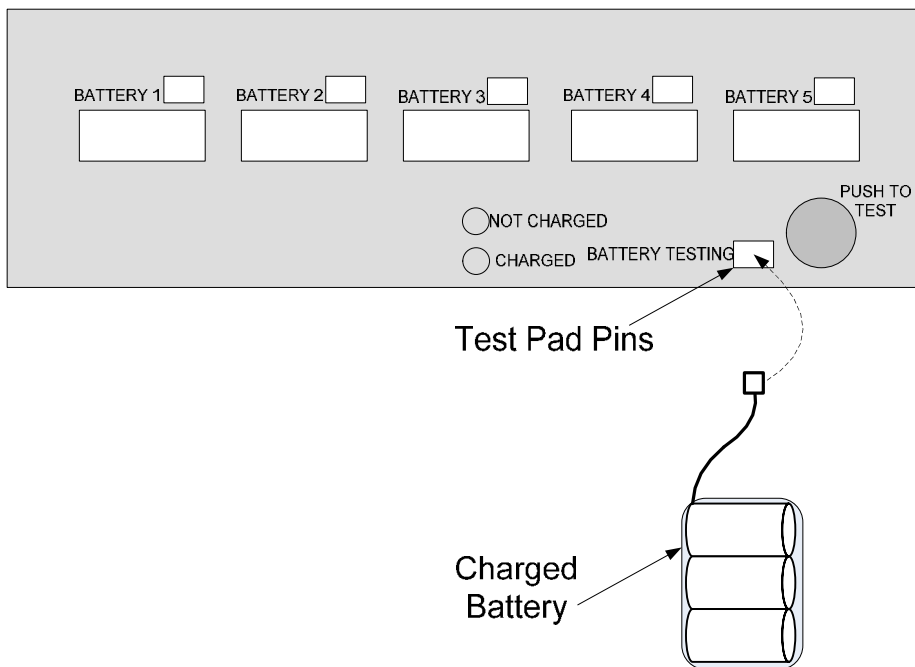

2. Once connected, press and hold the “push to test” button. While pressing the button look at the Test Pad LED’s to determine battery state. If labelled as “NOT CHARGED”, place on charger back in cradle and repeat charging cycle. Repeat up to 3 times and then if no change discard battery or call IgeaCare.

SAFETY INSTRUCTIONS

Do not force batteries into charging pins. Do not place on table face down. If charging pins are shorted do not plug into power source. There is no electrical current flowing through the exposed pins. At no point will the charger or batteries be hot to touch. **If a battery heats up remove and discard immediately.** Do not place fingers between plates on gang charger. Lift charger using the bottom plastic.

Quality Care through innovative technology

igeacom User Guide

V3.0



IgeaCare Systems Inc.

www.igeacare.com
Toll Free: 1.866.361.6225

Part Number 9001001M

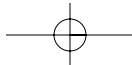
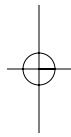
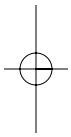
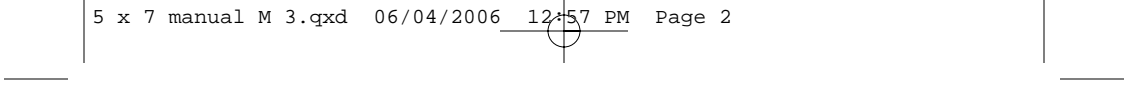

Quality Care through innovative technology

igeacom User Guide

V3.0



IgeaCare Systems Inc.

www.igeacare.com
Toll Free: 1.866.361.6225

Part Number 9001001M

igeacom User's Guide
Version 3.0

FIRST EDITION
October 2005

SECOND EDITION
January 2006

THIRD EDITION
April 2006



COPYRIGHT

©2006 by IgeaCare Systems Inc. All rights reserved. The content of this document is for information purposes only and is subject to change without notice. IgeaCare Systems Inc. assumes no liability or responsibility for any errors which may appear within this document. The material presented herein should not be construed as a commitment or warranty. No part of this publication may be reproduced, transmitted, transcribed or translated into any language in any form by any means without the express written permission of IgeaCare Systems Inc.

SOFTWARE LICENSE NOTICE

Your license agreement with IgeaCare Systems Inc., which is included with the product, specifies the permitted and prohibited uses of the product. Any unauthorised duplication or use of igeacom Version 3.0 in whole or in part, in print, or in any other system is prohibited.

LICENSES AND TRADEMARKS

Macintosh is a trademark of Apple Computer, Inc.
The igeacom logo is a registered trademark of IgeaCare Systems Inc.
QuarkXpress is a registered trademark of Quark, Inc.
Adobe Photoshop is a registered trademark of Adobe Systems Incorporated.

All other brand or product names mentioned in this user's guide are trademarks or registered trademarks of their respective holders.

This document has been produced using QuarkXpress.
All graphics have been taken from the IgeaCare application using Windows Print Screen function and enhanced using Adobe Photoshop.

IgeaCare Systems Inc. wishes to sincerely thank all of the individuals who made this product possible.

IgeaCare Systems Inc.
9033 Leslie Street, Unit #7, Richmond Hill, ON L4B 4K3
Visit our Web site at: www.igeacare.com
Printed In Canada

Contents

Section 1 - User Overview

Requesting Help	1-3
Cancelling a Call	1-4
Increasing/Decreasing Volume	1-4
Retrieving Menus & Activities	1-5
Indicator Lights	1-6
Line Indicator	1-6
Fault Indicator	1-7
Activities Indicator	1-8
Menu Indicator	1-8
Indicator Lights warning Chart	1-9
Warranty & Certification	1-10

Section 2 - Circuit Board Overview

Overview	2-3
Installation Requirements	2-4
Internal Hardwire Input connections	2-5

Section 3 - Diagnostic Procedures

Diagnostic Procedures during Boot-up	3-3
Maintenance Dial String	3-5

Section 4 - Programming

Overview	4-3
1.0 Parameters	4-3
2.0 Calling	4-4
2.1 Hardwire Buttons	4-4
2.2 RF Modules	4-4
3.0 Call Recognition	4-4
4.0 Cancelling	4-7
5.0 Redialing	4-7
6.0 Call Priority	4-8

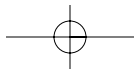
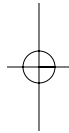
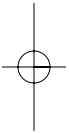

1

User Overview

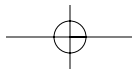
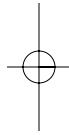
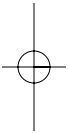

User Overview

Using the igeacom Emergency Call Device:

The igeacom emergency call device is easy to use.

Requesting Help:

› To Request Help:

Press the red call button on the unit,

or

Press the red button on the pendant,

or

Press the red button on the push cord

or

Toggle any of the pull cords.

By activating any one of the peripheral devices your igeacom emergency call device will send a signal to the emergency call unit to call the emergency call station or control center.

All of your peripheral devices can be programmed according to their priority or associated degree of emergency as programmed by the facility for each device.

Up to 4 Wireless Pendants and 4 Wireless Pull cords can be programmed to an igeacom500.



User Overview

Canceling a call:

If you accidentally activate an alarm call you can cancel the call from the emergency call unit.

›To Cancel a Call: (Emergency Call Unit)

Press the green cancel button.

The wireless pull cord can also be cancelled at the source.



›To Cancel a Call: (Wireless Pull Cord)

Push down on the cancel area.

If the call is accepted by the operator prior to cancelling the call, simply explain to them it was an error and the operator or yourself can then cancel the call.



Increasing/Decreasing Volume

It is easy to increase or decrease the volume of your emergency call device.

›To Increase the Volume:

Press the up arrow

›To Decrease the Volume:

Press the down arrow.



User Overview

Retrieving Menus & Activities

The black buttons labeled **Menu** and **Activities** on the igeacom emergency call unit activate the menu or activity announcements for the week or day, as programmed by your facility.

› To Retrieve the Menu

Press the black **Menu** button to hear a pre-recorded announcement.



› To Retrieve Activities

Press the black **Activities** button.



User Overview

Indicator Lights

Line Indicator:

The **Line** indicator LED will turn on when:

- a) The call button has been pressed,



- b) An igeacom device, e.g. the pendant, has been triggered.



The **Line** LED will also appear in combination with the **Fault** LED indicator if:

- a) the emergency call device detects a fault in the line.



If the **Line** or **Fault** LED remains on for a period longer than 20 seconds then the resident should inform the central station or operator immediately. The **Line** LED will flash every 5 minutes along with the **Fault** LED should a problem be indicated. If both LED's appear the resident should inform the central station or operator immediately.

User Overview

Fault Indicator:

The **Fault** indicator LED indicates that there is a possible fault with your emergency call device.

If the **Fault** LED indicator appears you should immediately contact the operator and request assistance so that your system can be examined and/or repaired.



The **Fault** LED indicator will appear if the emergency call device detects a fault in the keypad, line or unit.

User Overview

Activities Indicator:

The **Activities** LED indicator will turn on/flash when the menu button has been pressed.



Menu Indicator:

The **Menu** LED indicator will turn on/flash when the menu button has been pressed.



User Overview

Indicator Lights Warning Chart

Light Indicator Lit	Condition	Solution
Line	Call button pressed	If assistance not required cancel the call to reset unit.
Line	Device triggered, e.g. pendant	If device is not in use turn it off.
Line & Fault	Fault in line. When a no line fault occurs a short chirp will sound of 70ms in duration	Call Operator immediately
Fault	Fault in keypad. When a keypad error occurs a short chirp will sound for 70ms in duration.	Call operator immediately
Fault	Fault with unit	Call Operator immediately
Activities & Fault	Battery warning. The device will chirp (2 beeps) for a duration of 160ms.	Call Operator immediately. Battery should be recharged.
Activities, Line & Fault	Battery life is low a long chirp will sound for 560ms.	Call Operator immediately. Replace Battery

User Overview

Warranty & Certification

If you would like to report a fault or return an igeacom device for warranty repair, please complete the online form at: <http://www.igeacare.com/support.htm>

All igeacom devices have a one year warranty against manufacturer defect. The igeacom wireless pull cord battery and wireless pendant battery have a five year warranty.

Please register your igeacom device online at:
<http://www.igeacare.com/support.htm>

The igeacom 100, 300 and 500 are CSA certified:

- 1) Class 481205
CSA Std C22.2 No. 205 - m1983 signal equipment;
CAN/CSA - 22.2 No. 60950 -1-03;
Bi-national standard with UL 60950-1
- 2) CSA-US
Class 481284
Class 481204
CSA Std C22.2 No 205-m1983;
UL Std No. 464, Eight ed 2003

CAN/CSA 22.2 No. 60950-1-03;
Bi-National standard with UL 60950-1
- 3) igeacom300 & igeacom500
FCC ID:SEDIGEACOM
IC: 5263A-IGEACOM

Operation is subject to the following two conditions: (1) This device may not cause interference, and (2) This device must accept any interference, including interference that may cause undesired operation of the device.

"NOTE: THE MANUFACTURER IS NOT RESPONSIBLE FOR ANY RADIO OR TV INTERFERENCE CAUSED BY UNAUTHORIZED MODIFICATIONS TO THIS EQUIPMENT. SUCH MODIFICATIONS COULD VOID THE USER'S AUTHORITY TO OPERATE THE EQUIPMENT."

Overview

Warranty

a) Hardware Products Warranty. For a period of one (1) year, IgeaCare Systems Inc. warrants that (i) the hardware portions of any Product will operate in accordance with IgeaCare Systems Inc.'s published specifications and documentation for the product on the date it is shipped, (ii) all Nurse Call Hardware Products will be made from entirely new parts. Replacement parts are warranted for ninety (90) days or for the remainder of the warranty period in effect on the original product, whichever is greater.

b) Limited Software Warranty. For a period of one (1) year, IgeaCare Systems Inc. warrants that (i) the Software will materially conform to IgeaCare Systems Inc.'s then-current documentation and specifications for such Software; (ii) the media containing the Software (but not the software itself) is free from physical defects; (iii) IgeaCare Systems Inc. shall, within ninety (90) days furnish replacement media containing the Software that is free from physical defects

c) Software Maintenance and Upgrade Options. For a period of ninety (90) days from the purchase date, IgeaCare Systems Inc. will provide without charge for delivery to such End User upgrades and support services in accordance with IgeaCare Systems Inc.'s standard support terms and conditions.

d) Battery Warranty. For a period of five (5) years, IgeaCare Systems Inc. shall replace the battery/batteries in any hardware product.

Exclusive Warranties.

THE FOREGOING WARRANTIES AND REMEDIES ARE EXCLUSIVE AND ARE IN LIEU OF ALL OTHER WARRANTIES, EXPRESS OR IMPLIED, EITHER IN FACT OR BY OPERATION OF LAW, STATUTORY OR OTHERWISE INCLUDING WARRANTIES OF MERCHANTABILITY, FITNESS FOR A PARTICULAR PURPOSE AND NON-INFRINGEMENT OF THIRD PARTY RIGHTS TO THE FULLEST EXTENT PERMITTED BY LAW. IGEACARE SYSTEMS INC. NEITHER ASSUMES NOR AUTHORIZES ANY OTHER PERSON TO ASSUME FOR IT ANY OTHER LIABILITY IN CONNECTION WITH THE SALE, INSTALLATION, MAINTENANCE OR USE OR THE RESULTS OF THE USE OF THE NURSE CALL HARDWARE PRODUCTS AND/OR LICENSED PRODUCTS, DOCUMENTATION NOR ANY OTHER ITEMS OR MATERIALS PROVIDED HEREUNDER IN TERMS OF CORRECTNESS, COMPLETENESS, ACCURACY, RELIABILITY, OR OTHERWISE, AND IGEACARE SYSTEMS INC. MAKES NO WARRANTY WHATSOEVER OF ANY NONSTANDARD PRODUCTS SUPPLIED BY IT HEREUNDER. (Neither Nurse Call Hardware Products nor Software shall be deemed "nonstandard products" for the purposes of this paragraph.)

Overview

IGEACARE SYSTEMS INC. SHALL NOT BE LIABLE UNDER THIS WARRANTY IF THE ALLEGED DEFECT IN THE PRODUCT DOES NOT EXIST OR ANY THIRD PERSON'S (FOR WHOM IGEACARE SYSTEMS INC. IS NOT RESPONSIBLE AS PROVIDED HEREIN) MISUSE, NEGLIGENCE, IMPROPER INSTALLATION OR TESTING, UNAUTHORIZED ATTEMPTS TO REPAIR, OR ANY OTHER CAUSE BEYOND THE RANGE OF THE INTENDED USE, OR BY ACCIDENT, FIRE, LIGHTNING OR OTHER HAZARD.

Limitation of Liability.

IN NO EVENT, WHETHER BASED IN CONTRACT OR TORT (INCLUDING NEGLIGENCE) SHALL IGEACARE SYSTEMS INC. BE LIABLE FOR INCIDENTAL, CONSEQUENTIAL, INDIRECT, SPECIAL OR PUNITIVE DAMAGES OF ANY KIND, OR FOR LOSS OF REVENUE, LOSS OF BUSINESS, LOST PROFITS OR LOST OR INACCURATE DATA, OR COST OF COVER, PROCUREMENT OF SUBSTITUTE PRODUCTS, TECHNOLOGY OR SERVICES OR OTHER FINANCIAL LOSS ARISING OUT OF OR IN CONNECTION WITH THIS AGREEMENT OR THE SALE, INSTALLATION, MAINTENANCE, USE, PERFORMANCE, FAILURE OR INTERRUPTION OF ITS PRODUCTS. THIS DISCLAIMER OF LIABILITY FOR DAMAGES WILL NOT BE AFFECTED IF ANY REMEDY PROVIDED HEREUNDER SHALL FAIL OF ITS ESSENTIAL PURPOSE.

2

Circuit Board Overview

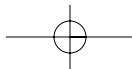
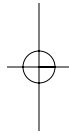
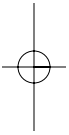

Circuit Board Overview

Circuit Board(s)

The igeacom combines all your communication needs into one system. The igeacom is available in two models, the **igeacom300** and **igeacom500**. The igeacom300 can easily be upgraded to include all the peripheral devices of the igeacom500.

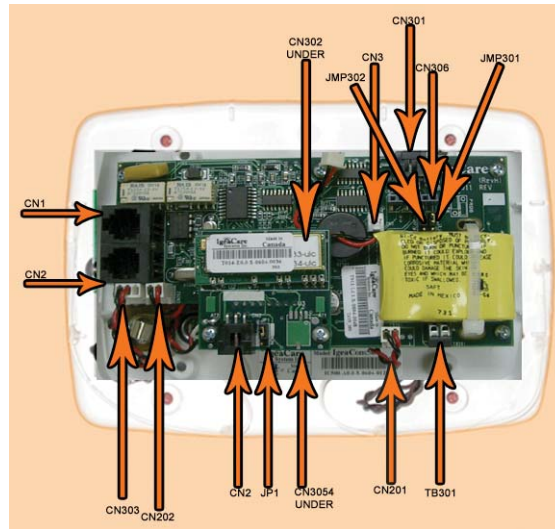

TAV011 (Main Board)
TAV012 (Keypad Board)



TAV011 (Main Board)
TAV012 (Keypad Board)
TAV014 (Receiver Board)
TAV013 (Output Relay Module)
TAV020 (Personal RF Pendant)
TAV030 (Wall RF Pendant)

Circuit Board Overview

All circuit boards indicate PCB manufacturer logo and UL listing. Boards are 1/16" thick made from FR-4 material.

There is no handset or metal contacts for the end user. The igeacom is permanently fixed to a wall and installed into a standard three gang box 2.5" deep.

The igeacom is line powered (phone line); its on hook current consumption is approximately 1.5mA and its off hook current consumption is approximately 27mA.

There are several keypads to dial pre-arranged numbers.

There are also two peripheral devices (TAV020, TAV030), which trigger pre-arranged numbers for the main board to dial.

The pre-arranged phone numbers are all downloaded into the igeacom via an infra-red communication link.

Installation requirements: The igeacom circuit board clearance requires that the igeacom be installed using a standard 2.5" deep, 3 5/8" wide and 5.5" length 3-gang box. This 3-gang box will enable the igeacom to be securely mounted.

Circuit Board Overview

Internal Hardwire Input Connections for TAV011 (Main Board)

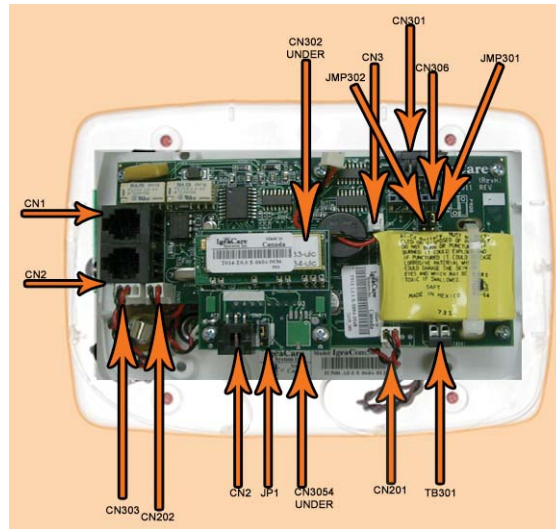

Connector	Use
CN1	One telephone input line cord (40mA-50mA) with standard modular telephone plug.
CN2	One telephone output line cord (40mA-50mA) with standard modular telephone plug. It is used as an extension for a telephone.
CN3	Two pin header is used for the connection of the Ni-Cd 3.6V battery pack assembly.
TB301	Terminal block hook up is for normally open contacts such as wall mount pull cords.

Circuit Board Overview

CN301 Six pin connector is used for updating and reading the software (within the micro-controller U301) responsible for the function of the entire igeacom unit.

Note: *Only a qualified technician should be using this connector.*

CN302 Eight pin socket is used for the connection of the Keypad board TAV012.

CN303 Three pin header is for the phone jack connection, which is a normally open contact.

CN305 Eight pin socket is used for the connection of the Receiver board TAV014.

CN306 Six pin socket is used for the connection of the Output Relay Module board TAV013.

CN201 Two pin header is used for the connection of the speaker assembly.

CN202 Two pin header is used for the connection of the microphone assembly.

TAV030 (Wall RF-Pendant)

This device transmits at 433.92MHz with OOK modulation. The maximum current transmission is 10mA. The transmitter is also a third party device.

3

Diagnostic Procedures

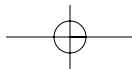
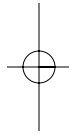
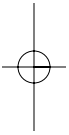

Diagnostic Procedures

Diagnostic Procedures during Boot-up:

Before mounting the igeacom unit, the battery must be plugged into connector CN3.

Please note the igeacom will then perform the following diagnostics:

1. An audio beep along with the 4 front LED's turn on for a duration of 600 ms. (____).

This tells the installer that the unit has booted up properly and that the battery is okay. If this condition is not met the unit must be replaced.

2. Three audio beeps for a duration of 200 ms each (_ _ _).

This indicates that the unit has gone through the cancellation routine which prepares the unit for standby mode. If this condition is not met the unit must be replaced.

3. The unit checks for two more conditions:
 - a. The unit will check to see if a telephone line has been connected to CN1.

*Since we have not hooked up a telephone line yet the unit will chirp and the **Line** and **Fault** LED's will light up for a duration of 50 ms.*

Diagnostic Procedures

- b. The unit will check to see if any buttons have seized and check battery conditions.
*If this fault occurs the unit will chirp and the **Fault** LED will light up for a duration of 50 ms.*

Note:

- i. In standby mode every 5 minutes the unit will perform diagnostic check (3) of the unit and check for all the items listed on page 1-9.
- ii. While in working mode the unit will perform diagnostic check (3) continuously.
- iii. If all of the above parameters pass, then plug the telephone line into CN1 and the telephone extension into CN2.

Press the **Cancel** button.

This verifies and checks step 1-3 again.

You will notice that step 3 (B) will not occur. If it does occur the unit must be replaced.

4. The unit can also perform the diagnostic procedure by simultaneously pressing the **Menu & Activities** buttons, it will:
 - i. Check for the line;
 - ii. Check for a battery warning;
 - iii. Check to see if the battery voltage is low;
 - iv. Check to see if the keypad has a seized button.

Diagnostic Procedures

5. If the fault light appears on the unit, simultaneously followed by the sound of 2 short chirps 90 ms each, then this indicates:
 - i. The battery is below operating voltage;
 - ii. The battery is not plugged in, or
 - iii. The battery is damaged

When the unit detects this fault, the unit will lock you out from making a call until the unit has been looked at by the site technician.

To reset the unit simply press the **Menu**, **Activities**, **Cancel** and **Volume** buttons simultaneously.

The unit is ready to be securely mounted to the wall if it passes all the diagnostic procedures.

6. Maintenance Dial String

When the battery of the igeacom unit falls below the acceptable working threshold voltage or if any call point has remained in a seized state the unit will automatically dial out the maintenance dial string.

Diagnostic Procedures

The Maintenance dial string includes a delay timer. The delay timer is programmable in minutes. The timer provides an open path to the called party. Once the timer ends the path is closed. The speaker will be set to lowest volume when a maintenance call is placed. The dial string will be called once and after the corresponding dial string the unit will wait a set delay timer of 60 minutes. If the problem is not corrected within 60 minutes the igeacom will redial the maintenance string again. This procedure will cycle until the trouble is corrected.

The *9 user code is always active on a maintenance call even if disabled for a traditional nurse call function. However, *9 will not cancel a maintenance call but rather release the line for the remainder of the delay timer.

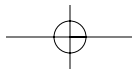
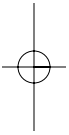

4

Programming

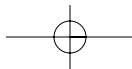
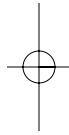
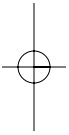

Programming

Overview



The igeacom is fully programmable via infra-red link.

› **To place the igeacom into Infra-red Download Mode:**

Simultaneously press both **Volume** buttons for approximately 5 seconds.

› **To End Infra-red Download:**

Once the parameters are downloaded and verified press both **Volume** buttons to end system download.

1.0 Parameters

The parameters that we can download are:

- 1.1 Phone Numbers
- 1.2 Redial Delays
- 1.3 Redial Yes/No
- 1.4 Silent Dialing Yes/No
- 1.5 Color Dome Light White/Red/Blue
- 1.6 Priority (from Highest =1 to Lowest=6)

Programming

2.0 Calling

The call can be done via hard wired buttons or RF modules:

2.1 Hard wired buttons:

- 2.1.1.1 Red Call Button
- 2.1.1.2 Pull Cord
- 2.1.1.3 Emergency Cord (plugs into jack)
Push Button Call Cord

2.2 RF modules

- 2.2.1.1 RF pendant
- 2.2.1.2 RF Wall-mount (this unit also has a cancel RF button)

3.0 Call Recognition:

- 3. Call recognition is accomplished by dialing *4 or *3 on any wired or wireless telephone.
 - 3.1 If the recipient performs the call recognition code by phone, he/she will hear acknowledgement tones to verify the code has been recognized.

Programming

3.2 The igeacom unit will perform different functions depending on which recognition code is pressed.

a) Once the *4 call recognition code is entered the igeacom will disconnect the telephone line without cancelling the call. At this point the call must be cancelled using the green cancel button on the igeacom. If the call is not cancelled after the programmed *3 call recognition timer the igeacom will redial the first dial string.

If the *4 call recognition code is not pressed the resident will hear a fast busy tone through the igeacom speaker for the remainder of the programmed delay timer.

b) Once the *3 call recognition code is entered he/she will hear acknowledgement tones to verify the call has been recognized. At this time, a delay timer (user definable in minutes) is started and the two-way speech path is still open between the caller and called party. If the called party remains on the line for the duration of the delay timer at the final minute the recipient of the call will hear two warning tones for a duration of 100 ms each through the telephone.

Programming

These tones will sound off every 10 seconds for the remainder of the last minute. If the timer expires the unit will hang up and redial the first dial string. To extend the delay timer the user can enter *3 during the last minute or while they hear the warning tones. This time extension can be performed a maximum of two times for every emergency call.

Programming

4.0 Cancelling

The Cancel Operation can be done in two ways:

- 4.1 Pressing the green **Cancel** button
- 4.2 By phone, dialing *9.
If the recipient performs the cancel operation by phone he/she will hear the acknowledgement tones to verify the call has been cancelled.

Note: These tones sound different from the Call recognition tones. When installed, *9 may be disabled per igeacom.

5.0 Redialing

If the call is not answered within the time named Redial Delay (1.2), system may:

- 5.1 Dial the next phone number, if the parameter named Redial (1.3) is programmed **Yes**.
- 5.2 Hang up, if the parameter named Redial (1.3) is programmed **No**.

If the call is answered:

- 5.3 If the call is answered and the recipient hangs up without Call Recognition (3) or Cancel Operation (4) then Redialing takes place once the Redial Delay (1.2) has passed for that call.

Programming

- 5.4 If the call is answered and the recipient does not enter the Call Recognition (3) the following will occur:
While talking on the phone the Redial Delay (1.2) continues to count down, once the Redial Delay timer has reached the specified delay time the unit will hang up and proceed to steps 5.1 and 5.2.
- 5.5 If the call is answered and the recipient acknowledges the call with the Call Recognition (3) and then hangs up without the Cancel Operation (4) the call will redial the same number after the Call Recognition timer expires.

6.0 Call Priority

- 6.1 To any calling button (hard wired and RF) is associated a programmable priority (parameter 1.6). The most urgent button can interrupt the less urgent one.

Note:

The **Menu** and **Activities** buttons have the lowest priority.

7.0 RF Module Learning Process

The RF modules (2.2.1.1 and 2.2.1.2) will be learned by the system, following this procedure:

- 7.1 Put the system into learn mode by pressing the **Cancel** and **Menu** buttons simultaneously for approximately 5 seconds.
- 7.2 Activate the RF module. The system will confirm the End of Learning Process by a long beep, passing automatically to normal mode.
- 7.3 Up to 4 Wireless Pendants and 4 Wireless Pullcords can be programmed to an igeacom500.

Please note that once a fifth RF peripheral device (wireless pendant or wireless pull cord) is programmed, the previous four RF peripheral devices will no longer maintain their programming. Therefore, all RF's require to be tested after programming to ensure that they are all programmed to the igeacom500 and functioning properly. If you encounter a problem during the programming phase and the RF's are not recognized, then you will be required to re-program the igeacom RF peripherals to the igeacom500. Please follow the re-testing procedure until all for RF peripheral devices are recognized by the igeacom500.

Feature Release date April 2006

Section 3 - Diagnostic Procedures - Maintenance Dial String:

When the battery of the igeacom unit falls below the acceptable working threshold voltage or if any call point has remained in a seized state the unit will automatically dial out the maintenance dial string.

The Maintenance dial string includes a delay timer. The delay timer is programmable in minutes. The timer provides an open path to the called party. Once the timer ends the path is closed. The speaker will be set to lowest volume when a maintenance call is placed. The dial string will be called once and after the corresponding dial string the unit will wait a set delay timer of 60 minutes. If the problem is not corrected within 60 minutes the igeacom will redial the maintenance string again. This procedure will cycle until the trouble is corrected.

The *9 user code is always active on a maintenance call even if disable for traditional nurse call function. However, *9 will not cancel a maintenance call but rather release the line for the remainder of the delay timer.

Feature Change Release date April 2006

Section 4 - Programming - Call Recognition:

3. Call recognition is accomplished by dialing *4 or *3 on any wired or wireless telephone:

- a. If the recipient performs the call recognition code by phone, he/she will hear acknowledgement tones to verify the code has been recognized.
- b. The igeacom unit will perform different functions depending on which recognition code is pressed.
 - i. Once the *4 call recognition code is entered the igeacom will disconnect the telephone line with out cancelling the call. At this point the call must be cancelled using the green cancel button on the igeacom. If the call is not cancelled after the programmed *3 Call Recognition timer the igeacom will redial the first dial string.

If the *4 call recognition code is not pressed the resident will hear a fast busy tone through the igeacom speaker for the remainder of the programmed delay timer.

- ii. Once the *3 call recognition code is entered he/she will hear acknowledgement tones to verify the call has been recognized. At this time, a delay timer (user definable in minutes) is started and the two-way speech path is still open between the caller and called party. If the called party remains on the line for the duration of the delay timer at the final minute the recipient of the call will hear two warning tones for a duration of 100 ms each through the telephone.

These tones will sound off every 10 seconds for the remainder of the last minute. If the timer expires the unit will hang up and redial the first dial string. To extend the delay timer the user can enter *3 during the last minute or while they hear the warning tones. This extension can be preformed a maximum of two times for every emergency call.